



Meaningful Innovation.

WEEE Number: 80133970

INSTRUCTION MANUAL

DIMMABLE PIR SENSOR

TECHNICAL DATA

SKU	23742
INFRARED WAVELENGTH	5-14um
OUTPUT SIGNAL PEAK	≥3500mv
INSTALLATION HEIGHT	12m/39ft Max
DETECTION DISTANCE	≥3m/9ft
INPUT RANGE	12VDC
INPUT VOLTAGE RANGE	10-15VDC
INPUT CURRENT	≥30mA
OUTPUT SIGNAL	DIM 0-10V
OUTPUT CONNECTION	12VDC Input/ Black & White wire; DIM+/ Purple wire; DIM-/ Pink Wire



**IP65
RATING**

**03 YEAR
WARRANTY***

COMPATIBLE HIGHBAY

23736, 23737, 23738, 23739
(PURCHASE SEPARATELY)

SENSOR DATA

DETECTION AREA	25%/50%/75%/100%
HOLD TIME	5s/30s/1min/3min/5min/10min/20min/30min
DAYLIGHT THRESHOLD	Disable/ 2lux/ 10lux/ 30lux/ 50lux/ 80lux/ 120lux
STANDBY DIMMING LEVEL	10%/20%/30%/50%
STANDBY PERIOD	0s/10s/30s/1min/5min/10min/30min/60min +∞
DUST/DAWN SENSING/ PHOTOCCELL	Daylight Threshold as 30lux/50lux/80lux/120lux Standby Period as +∞; Standby dimming level as 10%/20%30%

STAND BY POWER <30mA Power Consumption

DEFAULT PROGRAM
Detection Area- 100%
Holding Time - 5s
Daylight Threshold - Disable
Standby Period -0s
Standby Dimming Level - 10%

REMOTE CONTROL
SKU-23743, With LCD Screen display remote (Purchase seperately)

WORKING TEMPERATURE
-20°C to +60°C

STORAGE TEMPERATURE
-40°C ~+80°C Humidity: 85% (non-condensation)



MULTI-LANGUAGE MANUAL QR CODE

Please scan the QR code to access the manual in multiple languages.



FR
Cet appareil, ses accessoires et cordons se recyclent

À DÉPOSER EN MAGASIN

OU

À DÉPOSER EN DÉCHÈTERIE

Points de collecte sur www.quefairedemesdechets.fr
Privilégiez la réparation ou le don de votre appareil !

In case of any query/issue with the product, please reach out to us at: support@v-tac.eu
For More products range, inquiry please contact our distributor or nearest dealers.
V-TAC EUROPE LTD. Bulgaria, Plovdiv 4000, bul.L.Karavelow 9B

INTRODUCTION & WARRANTY

Thank you for selecting and buying V-TAC product. V-TAC will serve you the best. Please read these instructions carefully before starting the installation and keep this manual handy for future reference. If you have any another query, please contact our dealer or local vendor from whom you have purchased the product. They are trained and ready to serve you at the best. The warranty is valid for 3 years from the date of purchase. The warranty does not apply to damage caused by incorrect installation or abnormal wear and tear. The company gives no warranty against damage to any surface due to incorrect removal and installation of the product. The products are suitable for 10-12 Hours Daily operation. Usage of product for 24 Hours a day would void the warranty. This product is warranted for manufacturing defects only.

WARNING

1. Please make sure to turn off the power before starting the installation.
2. Installation must be performed by a certified person.



This marking indicates that this product should not be disposed of with other household wastes.



Caution, Risk of electric shock

DIMENSIONS

Unit: mm

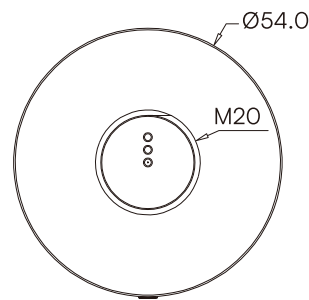
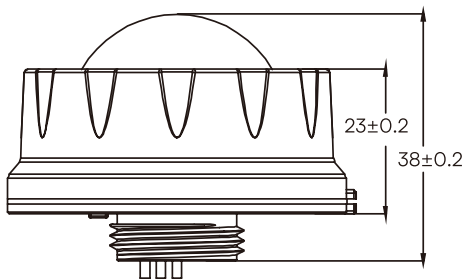

WIRING DIAGRAM

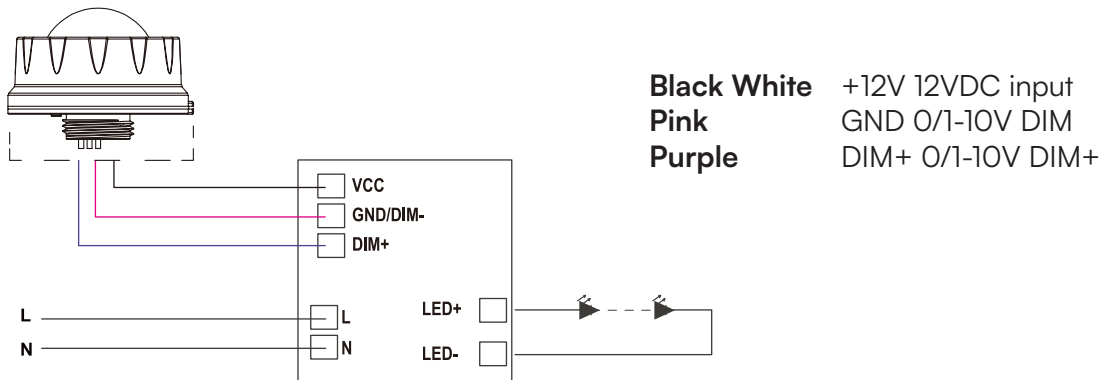

INSTALLATION INSTRUCTION

TYPE-A

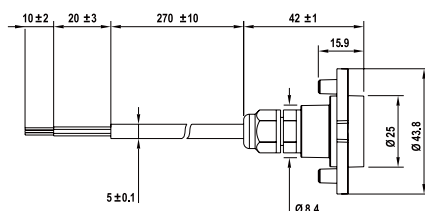

Wire color: Black/white, Pink, Purple
The length of the wire: 330mm

TYPE-B

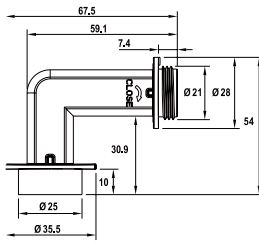

Wire color: Black/white, Pink, Purple
The length of the wire: 330mm

TYPE-C

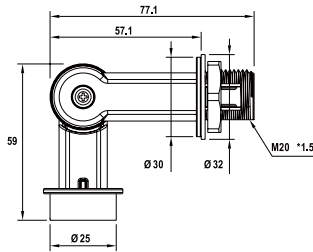

Wire color: Black/white, Pink, Purple
The length of the wire: 300mm

TYPE-D

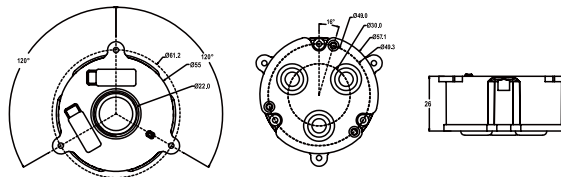

CCT & Power Adjustable Receptacle
Specially designed for UFO highbay light.

DETECTION COVERAGE

Mounting Height
<12 m/39.37ft Ceiling Mounted

Detection Distance
Radius 3-7m/9.84-22.96 ft

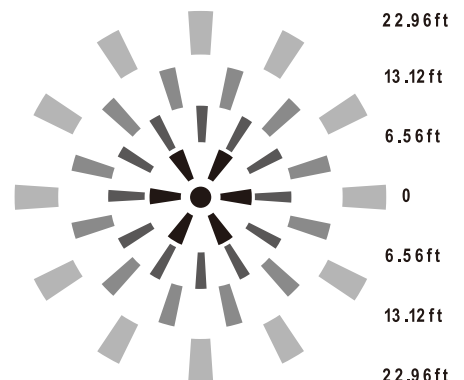
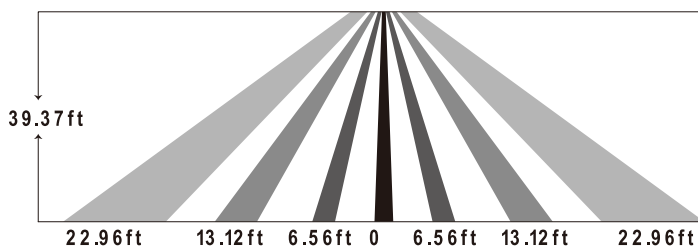

Mounting Height
 <6m/19.68 ft Ceiling Mounted

Detection Distance
 Radius 3-7 m/9.84-22.96 ft

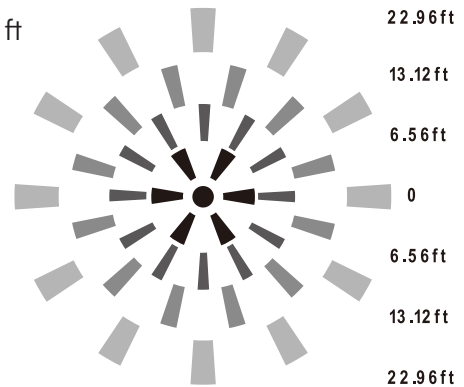
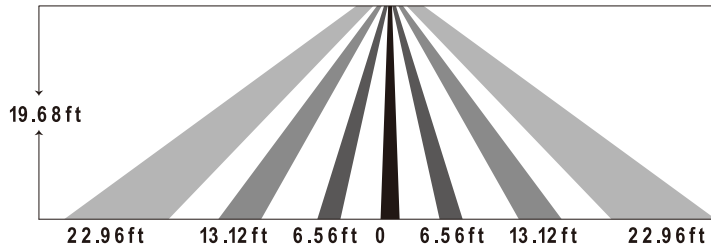

DUSK/DAWN FUNCTION

This sensor is able to differentiate artificial light brightness from natural light after installed inside the fixture, and automatically turn off light when ambient brightness exceeds preset lux level.

Precondition of Dusk/Dawn function:

1. Standby period is $+\infty$;
2. Standby dimming level is on 10%,20% or 30%;
3. Daylight threshold is on 30lux/ 50lux/ 80lux/ 120lux

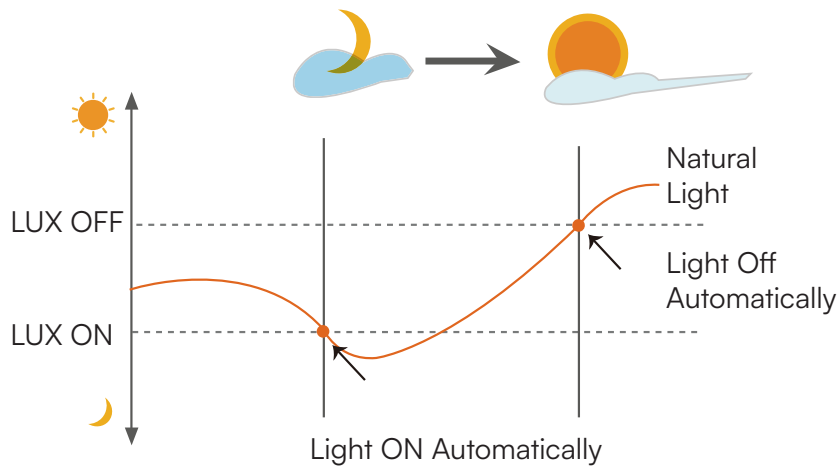

1. WITH DUSK/DAWN FUNCTION

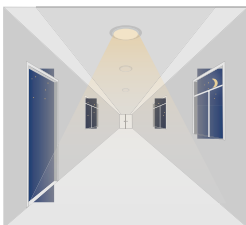

With insufficient ambient brightness, sensor turns on light and keeps it at standby dimming level even if there is no motion or presence.

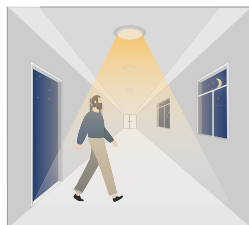

When sensor detects motion or presence it will bring the light level up to 100%.

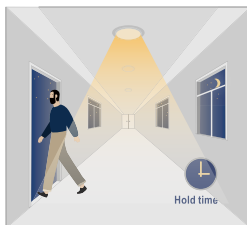

After motion is no longer detected, fixture remains at 100% for hold time.

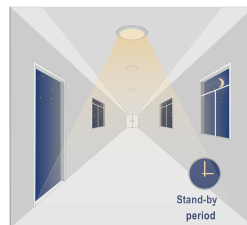

After pre-set hold time period it will dim light to standby dimming level again and always keep it.

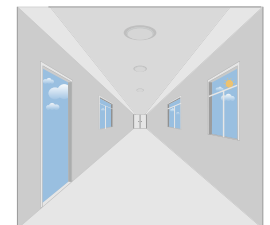

With sufficient ambient brightness, sensor will turn OFF light automatically.

2. WITHOUT DAYLIGHT DISABLED

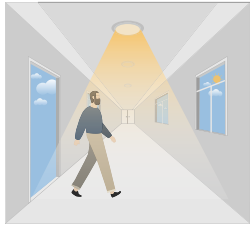

Sensor turns ON light when motion is detected.



Sensor keeps for a hold time period after motion leaves

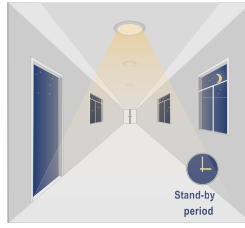

Sensor dims light to standby dimming level after hold time if there is still no motion

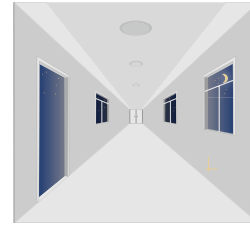

Sensor turns OFF light after standby period

3. WITH DAYLIGHT THRESHOLD

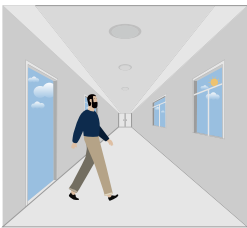

With sufficient daylight, the sensor keeps light OFF even motion gets detected.

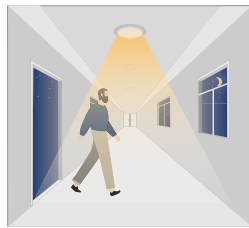

With insufficient daylight, the sensor turns light ON when motion gets detected

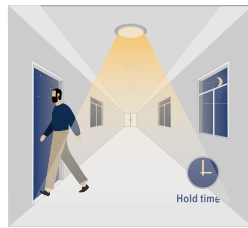

After there's no motion detected, the sensor keeps light ON 100% for holdtime



After holdtime, sensor dims light to standby dimming level for standby period. if the standby period has been set as Os, sensor turns light OFF automatically after holdtime.



The sensor turns OFF light automatically after the standby period when there's no motion detected.

APPLICATION NOTES

1. Suitable for indoor application, half/completely outdoor environment conditions might trigger the sensor.
2. Suitable for ceiling mount installation, adjust sensitivity properly if it's installed on side-wall because it gets more sensitive.
3. PIR sensor can't be placed inside any material, fresnel lens must be completely exposed in air.
4. Fresnel lens of the PIR sensor must be lower than light fixture.
5. Not suitable environment if there's sudden changed temperature of airflow for PIR sensor.
6. Not suitable environment if there's shelves blocking between the sensor and presence area.
7. Detection area options may NOT working obviously because it works depends on fresnel lens, it's physically defined.
8. Detection distance performance works better when moving parallelly than moving towards to the sensor.
9. Daylight testing delivered in bright day without shadow or specially designed lampshade or lens.
10. Dimming performance differs when connected to different drivers; If the driver can't completely turn OFF, sensor can't either.
11. Input power voltage must be stable with float less than 10%.
12. The first time powered ON sensor, light will be ON 100% for about 45S then dims to standby level or OFF.
13. Distance detection is delivered by testing person about 165cm in open area as reference, the result differs by size and speed of moving objects, mounting height and real-life situation.

RoHS



UK
CA

