

Column Radiator

(S35, D35, S70, D70)

Important Notes:

- The header with the flow / return connections contains a baffle and is identified by a sticker (shown on the right).
- Connections in the opposite header are used as vents or drains depending on the orientation of the radiator.
- TBSE (Top Bottom Same End) connections (AB/GE/HF/CD) and TBOE (Top Bottom Opposite End) connections (AC/CB/GF/HE) must be specified at time of order as they will NOT function correctly with a baffle.
- Ensure there is no trapped air in the radiator by adequately bleeding the system during installation.
- Flow rate may need to be adjusted/balanced for optimum performance.
- Radiator should be filled slowly from the bottom where possible.

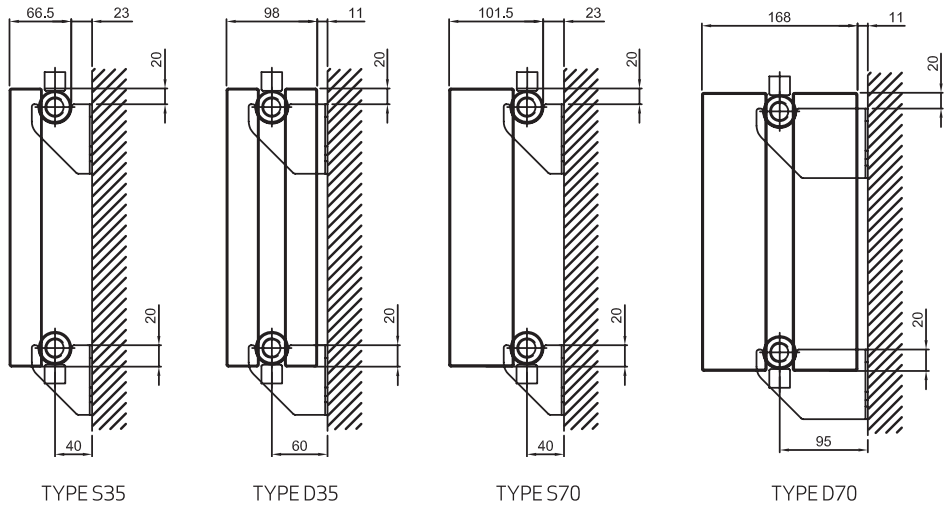

HOW TO CALCULATE CENTRE TO CENTRE DIMENSION

$$L = N \times S$$

$$E = (N-2) \times S$$

L = width of radiator
 N = number of elements
 S = element spacing
 E = centre to centre dimension for EFGH connections.

Model Element spacing (S)			
S35	D35	S70	D70
35mm	35mm	40mm	40mm

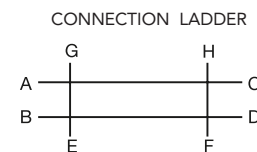
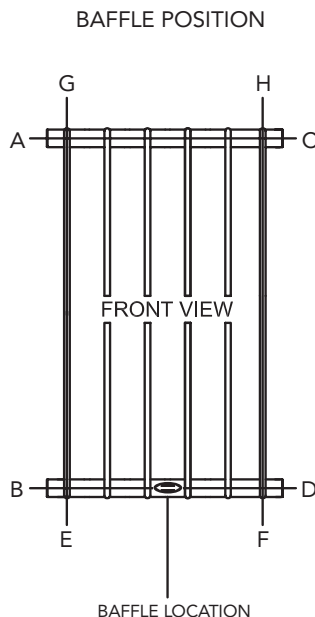
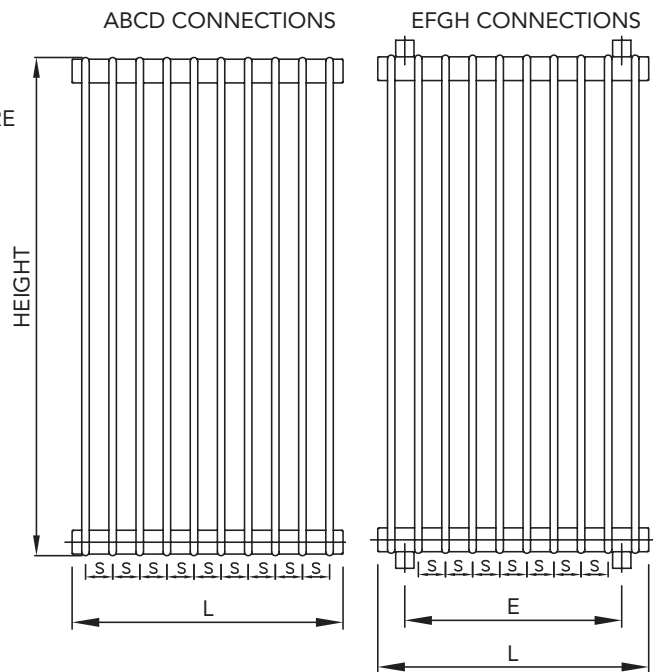

General information: The installation and commissioning of the system should comply with BS EN 14336:2004. On completion of the installation, the system should be properly flushed and filled in accordance with the British Code of Practice for the Treatment of Water in Domestic Hot Water Central Heating Systems (BS 7593:2006). We strongly recommend the use of a corrosion inhibitor. Failure to comply with these standards might invalidate the manufacturer's warranty.

All dimensions are in mm.

Purmo Group (UK) Ltd,
 Eastern Avenue,
 Team Valley, Gateshead,
 Tyne & Wear, NE11 0PG

Tel: 0845 402 34 34

Email: homedeliveries.uk@purmogroup.com

www.purmogroup.com

Information for the installer

Installation Procedure:

1. Choose the location where you wish to install the radiator and mark the positions for the wall brackets with a pencil as indicated in FIG. 1.
2. Measure the length & height as indicated in FIG. 1.
3. Place the wall brackets under the pencil marks on the wall as shown by points 1, 2, 3 & 4 in FIG. 1 and mark the positions of the wall plugs and screws, as indicated in FIG. 2.
4. Drill the necessary holes in the wall and install the wall brackets.
5. Fit air vents/drains to the radiator.
6. Mount the radiator on the wall brackets.
7. Connect the water supply via the flow valve.
8. The return line of the central heating system is connected to the opposite side of the radiator via the lockshield valve.
9. Fill the radiator and purge the air from the radiator using

Column Radiator

(S35, D35, S70, D70)

Fig 1

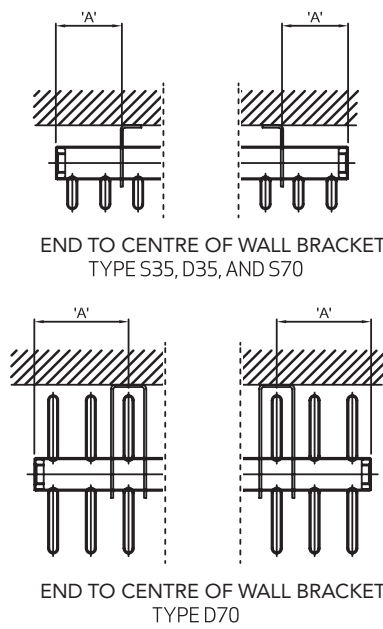

WALL BRACKET POSITION

LENGTH	'A' (mm)
S35 (35mm PITCH)	70
D35 (35mm PITCH)	70
S70 (40mm PITCH)	80
D70 (40mm PITCH)	100
S70 (50mm PITCH)	100
D70 (50mm PITCH)	125

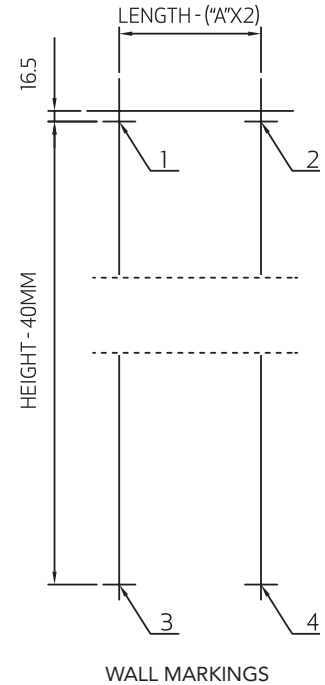
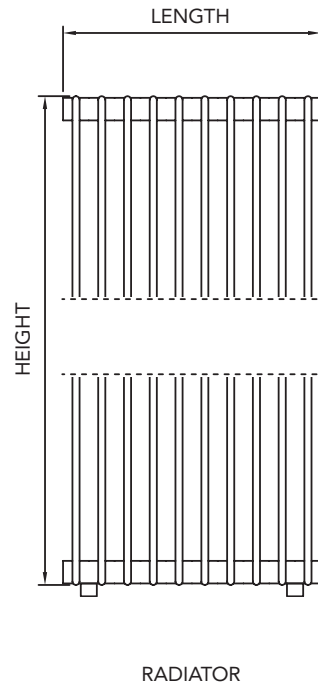
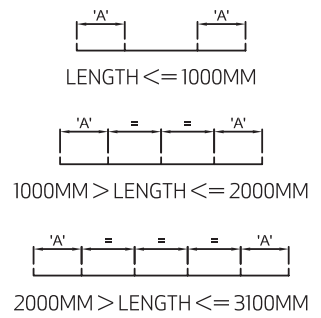

FIG. 2

