



DRAPER[®]

230V

TRI-BASE SANDER

57681



These instructions accompanying the product are the original instructions. This document is part of the product, keep it for the life of the product passing it on to any subsequent holder of the product. Read all these instructions before assembling, operating or maintaining this product.

This manual has been compiled by Draper Tools describing the purpose for which the product has been designed, and contains all the necessary information to ensure its correct and safe use. By following all the general safety instructions contained in this manual, it will ensure both product and operator safety, together with longer life of the product itself.

All photographs and drawings in this manual are supplied by Draper Tools to help illustrate the operation of the product.

Whilst every effort has been made to ensure the accuracy of information contained in this manual, the Draper Tools policy of continuous improvement determines the right to make modifications without prior warning.

1. TITLE PAGE

1.1 INTRODUCTION:

USER MANUAL FOR: 230V Tri-Base Sander

Stock No: 57681

Part No: TPS220D

1.2 REVISIONS:

Date first published November 2018.

As our user manuals are continually updated, users should make sure that they use the very latest version.

Downloads are available from: <http://drapertools.com/manuals>

Draper Tools Limited
Hursley Road
Chandler's Ford
Eastleigh
Hampshire
SO53 1YF
UK

Website: drapertools.com

Product Helpline: +44 (0) 23 8049 4344

General Fax: +44 (0) 23 8026 0784

1.3 UNDERSTANDING THIS MANUALS SAFETY CONTENT:

WARNING! – Information that draws attention to the risk of injury or death.

CAUTION! – Information that draws attention to the risk of damage to the product or surroundings.

1.4 COPYRIGHT © NOTICE:

Copyright © Draper Tools Limited.

Permission is granted to reproduce this publication for personal and educational use only. Commercial copying, redistribution, hiring or lending is prohibited.

No part of this publication may be stored in a retrieval system or transmitted in any other form or means without written permission from Draper Tools Limited.

In all cases this copyright notice must remain intact.

2. CONTENTS

1. TITLE PAGE	
1.1 INTRODUCTION.....	2
1.2 REVISION HISTORY	2
1.3 UNDERSTANDING THIS MANUAL	2
1.4 COPYRIGHT NOTICE	2
2. CONTENTS	
2.1 CONTENTS.....	3
3. WARRANTY	
3.1 WARRANTY.....	4
4. INTRODUCTION	
4.1 SCOPE.....	5
4.2 SPECIFICATION	5
5. HEALTH AND SAFETY INFORMATION	
5.1 GENERAL SAFETY INSTRUCTIONS FOR POWER TOOL USE	6-7
5.2 ADDITIONAL SAFETY INSTRUCTIONS FOR SANDERS	7
5.3 RESIDUAL RISK	7
5.4 CONNECTION TO THE POWER SUPPLY.....	8
6. TECHNICAL DESCRIPTION	
6.1 IDENTIFICATION	9
7. UNPACKING AND CHECKING	
7.1 PACKAGING	10
7.2 WHAT'S IN THE BOX.....	10
8. BASIC SANDER OPERATIONS	
8.1 SWITCHING ON/OFF	1
8.2 ABRASIVE SHEET INSTALLATION/REPLACEMENT	11
8.3 ABRASIVE PAPER	11
8.4 USING AS A FINGER SANDER/DETAIL SANDER.....	12
8.5 DUST.....	13
9. MAINTENANCE AND TROUBLESHOOTING	
9.1 MAINTENANCE	14
9.2 TROUBLESHOOTING	14
10. OPTIONAL ACCESSORIES	
10.1 OPTIONAL ACCESSORIES.....	14
11. EXPLANATION OF SYMBOLS	
11.1 EXPLANATION OF SYMBOLS	15
12. DISPOSAL	
12.1 DISPOSAL.....	16
DECLARATION OF CONFORMITY	ENCLOSED

3. WARRANTY

3.1 WARRANTY

Draper tools have been carefully tested and inspected before shipment and are guaranteed to be free from defective materials and workmanship.

Should the tool develop a fault, please return the complete tool to your nearest distributor or contact

Draper Tools Limited, Chandler's Ford, Eastleigh, Hampshire, SO53 1YF. England.

Telephone Sales Desk: (023) 8049 4333 or Product Help Line (023) 8049 4344.

A proof of purchase must be provided with the tool.

If upon inspection it is found that the fault occurring is due to defective materials or workmanship, repairs will be carried out free of charge. This warranty period covering labour is 12 months from the date of purchase except where tools are hired out when the warranty period is 90 days from the date of purchase. The warranty is extended to 24 months for parts only. This warranty does not apply to any consumable parts, any type of battery or normal wear and tear, nor does it cover any damage caused by misuse, careless or unsafe handling, alterations, accidents, or repairs attempted or made by any personnel other than the authorised Draper warranty repair agent.

Note: If the tool is found not to be within the terms of warranty, repairs and carriage charges will be quoted and made accordingly.

This warranty applies in lieu of any other warranty expressed or implied and variations of its terms are not authorised.

Your Draper warranty is not effective unless you can produce upon request a dated receipt or invoice to verify your proof of purchase within the warranty period.

Please note that this warranty is an additional benefit and does not affect your statutory rights.

Draper Tools Limited.

4. INTRODUCTION

4.1 SCOPE

This tri-base sander is intended for domestic and infrequent light trade use only. Any application other than that it was intended for, is considered misuse.

4.2 SPECIFICATION

Stock No.	57681
Part No.	TPS220D
Motor:	
Rated voltage	230V~
Rated frequency.....	50Hz
Rated input	220W
Revolutions per minute (no load)	13,000min ⁻¹
Pad size.....	96x148x148mm
Sound pressure level (LpA)*:	75dB(A)
Sound power level (LWA)**:	86dB(A)
Uncertainty (K):	3dB(A)
Vibration level	9.6m/s ² , K=1.5m/s ²
Weight	1.26kg

4.3 HANDLING & STORAGE

- Care must be taken when handling this product.
 - Dropping this power tool could have an effect on its accuracy and could also result in personal injury. This product is not a toy and must be respected.
- Environmental conditions can have a detrimental effect on this product if neglected.
 - Exposure to damp air can gradually corrode components.
 - If the product is unprotected from dust and debris, components will become clogged.
 - If not cleaned and maintained correctly or regularly, the machine will not perform at its best.

* *Continuous A-Weighted Sound Pressure Level at the workstation in accordance to and declared according to EN60745.*

** *The typical A-weighted noise level determined according to EN60745.*

5. HEALTH AND SAFETY INFORMATION

5.1 GENERAL SAFETY INSTRUCTIONS FOR POWER TOOL USE

When using any type of power tool there are steps that should be taken to make sure that you, as the user, remain safe.

Common sense and a respect for the tool will help reduce the risk of injury.

Read the instruction manual fully. Do not attempt any operation until you have read and understood this manual.

Most important you must know how to safely start and stop this machine, especially in an emergency.

Keep the work area tidy and clean. Attempting to clear clutter from around the machine during use will reduce your concentration. Mess on the floor creates a trip hazard. Any liquid spilt on the floor could result in you slipping.

Find a suitable location. If the machine is bench mounted, the location should provide good natural light or artificial lighting as a replacement. Avoid damp and dust locations as it will have a negative effect on the machine's performance. If the machine is portable do not expose the tool to rain. In all cases do not operate power tools near any flammable materials.

Keep bystanders away. Children, onlookers and passers by must be restricted from entering the work area for their own protection. The barrier must extend a suitable distance from the tool user.

Unplug and house all power tools that are not in use. A power tool should never be left unattended while connected to the power supply. They must be housed in a suitable location, away locked up and from children. This includes battery chargers.

Do not overload or misuse the tool. All tools are designed for a purpose and are limited to what they are capable of doing. Do not attempt to use a power tool (or adapt it in any way) for an application it is not designed for. Select a tool appropriate for the size of the job. Overloading a tool will result in tool failure and user injury. This covers the use of accessories.

Dress properly. Loose clothing, long hair and jewellery are all dangerous because they can become entangled in moving machinery. This can also result in parts of body being pulled into the machine. Clothing should be close fitted, with any long hair tied back and jewellery and neck ties removed. Footwear must be fully enclosed and have a non-slip sole.

Wear personal protective equipment (PPE). Dust, noise, vibration and swarf can all be dangerous if not suitably protected against. If the work involving the power tool creates dust or fumes wear a dust mask. Vibration to the hand, caused by operating some tools for longer periods must be protected against. Wear vibration reducing gloves and allow long breaks between uses. Protect against dust and swarf by wearing approved safety goggles or a face shield. These are some of the more common hazards and preventions, however, always find out what hazards are associated with the machine/work process and wear the most suitable protective equipment available.

Do not breathe contaminated air. If the work creates dust or fumes connect the machine (if possible) to an extraction system either locally or remotely. Working outdoors can also help if possible.

Move the machine as instructed. If the machine is hand held, do not carry it by the power supply cable. If the product is heavy, employ a second or third person to help move it safely or use a mechanical device. Always refer to the instructions for the correct method.

Do not overreach. Extending your body too far can result in a loss of balance and you falling. This could be from a height or onto a machine and will result in injury.

Maintain your tools correctly. A well maintained tool will do the job safely. Replace any damaged or missing parts immediately with original parts from the manufacturer. As applicable, keep blades sharp, moving parts clean, oiled or greased, handles clean, and emergency devices working.

5. HEALTH AND SAFETY INFORMATION

Wait for the machine to stop. Unless the machine is fitted with a safety brake, some parts may continue to move due to momentum. Wait for all parts to stop, then unplug it from the power supply before making any adjustments, carrying out maintenance operations or just finishing using the tool.

Remove and check setting tools. Some machinery requires the use of additional tools or keys to set, load or adjust the power tool. Before starting the power tool always check to make certain they have been removed and are safely away from the machine.

Prevent unintentional starting. Before plugging any machine in to the power supply, make sure the switch is in the OFF position. If the machine is portable, do not hold the machine near the switch and take care when putting the machine down, that nothing can operate the switch.

Carefully select an extension lead. Some machines are not suitable for use with extension leads. If the tool is designed for use outdoors, use an extension lead also suitable for that environment. When using an extended lead, select one capable of handling the current (amps) drawn by the machine in use. Fully extend the lead regardless of the distance between the power supply and the tool. Excess current (amps) and a coiled extension lead will both cause the cable to heat up and can result in fire.

Concentrate and stay alert. Distractions are likely to cause an accident. Never operate a power tool if you are under the influence of drugs (prescription or otherwise), including alcohol or if you are feeling tired. Being disorientated will result in an accident.

Have this tool repaired by a qualified person. This tool is designed to conform to the relevant international and local standards and as such should be maintained and repaired by someone qualified, using only original parts supplied by the manufacturer. This will ensure the tool remains safe to use.

5.2 ADDITIONAL SAFETY INSTRUCTIONS FOR SANDERS

Important: Draper Tools Limited recommends that this machine should not be modified or used for any application other than that for which it was designed. If you are unsure of its relative applications do not hesitate to contact us in writing and we will advise you.

1. Always wear a dust mask and suitable eye protection with sanders.
2. Connect dust extraction equipment. If the tool is provided for the connection of dust extraction and collecting equipment, ensure these are connected and properly used.

5.3 RESIDUAL RISK

Important: Although the safety instructions and operating manuals for our tools contain extensive instructions of safe working with power tools, every power tool involves a certain residual risk which can not be completely excluded by safety mechanisms. Power tools must therefore always be operated with caution!

5. HEALTH AND SAFETY INFORMATION

5.4 CONNECTION TO THE POWER SUPPLY

Caution: Risk of electric shock. Do not open.

This appliance is supplied with a moulded 3 pin mains plug for your safety. The value of the fuse fitted is marked on the pin face of the plug. Should the fuse need replacing, ensure the substitute is of the correct rating, approved to BS1362 and ASTA or BSI Kite marked.

ASTA 

BSI 

The fuse cover is removable with a small plain slot screwdriver. Ensure the fuse cover is replaced before attempting to connect the plug to an electrical outlet. If the cover is missing, a replacement must be obtained or the plug replaced with a suitable type.

If a replacement plug is to be fitted this must be carried out by a qualified electrician.

The damaged or incomplete plug, when cut from the cable should be disabled to prevent connection to a live electrical outlet.

This appliance is Class II[†] and is designed for connection to a power supply matching that detailed on the rating label and compatible with the plug fitted.

If an extension lead is required, use an approved and compatible lead rated for this appliance. Follow all the instructions supplied with the extension lead.

[†]Double insulated : This product requires no earth connection as supplementary insulation is applied to the basic insulation to protect against electric shock in the event of failure of the basic insulation.

IMPORTANT

If using an extension lead, follow the instructions that came with your lead regarding maximum load while cable is wound. If in doubt, ensure that the entire cable is unwound. Using a coiled extension lead will generate heat which could melt the lead and cause a fire.

6. TECHNICAL DESCRIPTION

6.1 IDENTIFICATION



- ① Soft grip.
- ② On/off switch.
- ③ LED worklight.
- ④ Hook & loop pad.
- ⑤ Dust collection.

7. UNPACKING AND CHECKING

7.1 PACKAGING

Carefully remove the product from the packaging and examine it for any sign of damage that may have happened during shipping. If any part is damaged or missing, please contact the Draper Help Line (the telephone number appears on the Title page) and do not attempt to use the product.

The packaging material should be retained at least during the guarantee period in case the machine needs to be returned for repair.

Warning!

- Some of the packaging materials used may be harmful to children. Do not leave any of these materials in the reach of children.
- If any of the packaging is to be thrown away, make sure they are disposed of correctly, according to local regulations.

7.2 WHAT'S IN THE BOX

As well as the product, there are several parts not fitted or attached to it.

- ⑥ Hook and loop detail base.
- ⑦ Hook and loop finger base.
- ⑧ 3 x assorted palm sanding sheets (hook and loop backed).
- ⑨ 3 x assorted detail sanding sheets (hook and loop backed).
- ⑩ 3 x assorted finger sanding sheets (hook and loop backed).

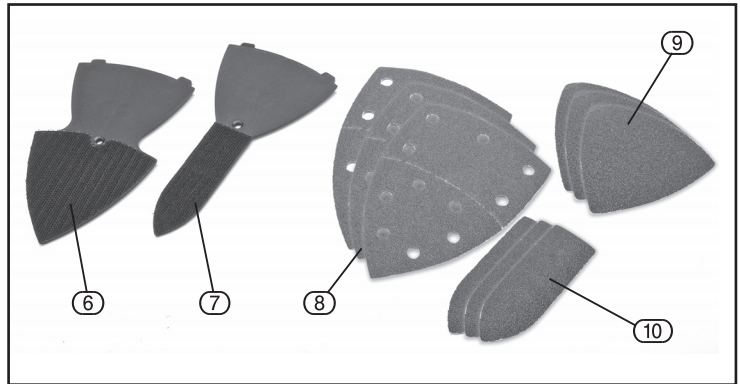

8. BASIC SANDER OPERATIONS

Note: Remove the plug from the socket before carrying out adjustment, servicing or maintenance.

8.1 SWITCHING ON/OFF – FIG. 1

Ensure the sander is raised off the workpiece.

To start the sander place the switch (2) to the “I” position. To stop the sander place the switch into the “O” position.

This machine is intended for light/medium duty sanding of wood and similar materials only.

Apply equal pressure on the workpiece with the base pad remaining flat. Attempting to sand areas using only the edge will lead to damage to the base pad.

Note: Excess pressure when sanding reduces the effectiveness of tool and will cause the motor to overload.

Do not overload this machine.

Abrasive sheets are consumable items. Replace abrasive sheets when clogged with material or when surface/edge has rips, cracks or worn areas.

8.2 ABRASIVE SHEET INSTALLATION/REPLACEMENT – FIG. 2

The sanding sheets are simply pressed onto the base pad. The holes in the sander must correspond to the holes in the sanding sheet for maximum dust extraction.

8.3 ABRASIVE PAPER

Only use good quality abrasive paper as this will improve the sanding efficiency and reduce working time. Use coarse grade (40, 60, or 80) sanding sheets when large quantities of material need to be removed. For finishing operations use 120 grade sanding sheets.

Note: Abrasive sheets and the sander base pad are consumable items.

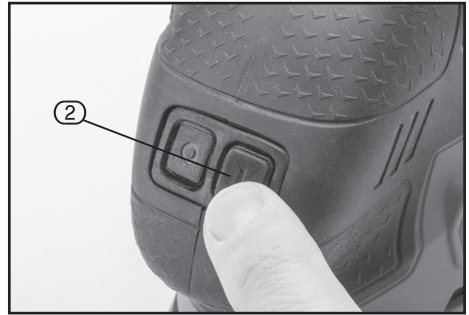

FIG.1

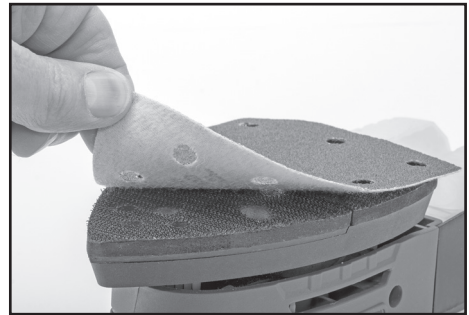

FIG.2

8. BASIC SANDER OPERATIONS

Note: Remove the plug from the socket before carrying out adjustment, servicing or maintenance.

8.4 USING AS A FINGER SANDER/DETAIL SANDER – FIGS. 3 - 6

Using a screwdriver, unscrew the fixing to the hook and loop base and remove completely.



FIG.3



FIG.4

Slide the attachment either (6) or (7) sanding base plate, making sure the lugs (7.1) slots into each recess.

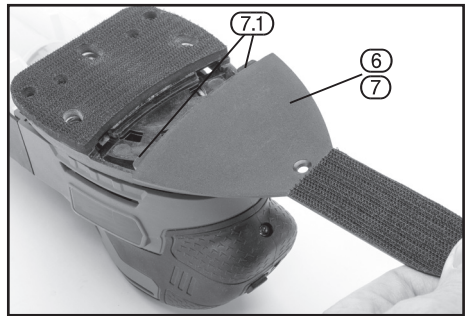

FIG.5

Ensure the attachment is aligned correctly onto the base plate and secure with fixing screw.
Press sanding sheet directly onto hook and loop base pad.

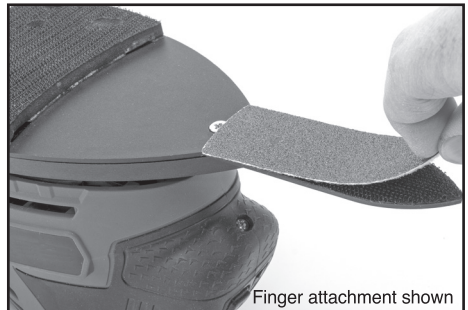

FIG.6

8. BASIC SANDER OPERATIONS

8.5 DUST

Inhalation of dust particles can be detrimental to health. The dust outlet can be connected to a dust extraction machine.

The dust extraction box can be used instead when connection to a dust extractor is not practical to reduce amount of air borne dust.

The dust box is attached by simply pushing it onto the outlet port until the sides of the box meet the body of the sander.

REMOVING AND EMPTYING THE DUST COLLECTION BOX

Disconnect the plug from the electricity supply.

Hold your sander vertically with the dust collector at the bottom.

Pull the box gently holding the grips on the side of the dust collection box.

Empty the dust box and shake out the filter, then replace on the sander.

A click is heard when the dust box is correctly fitted.

Do not wash the dust box/filter.

Empty the dust collection box/filter at regular intervals.

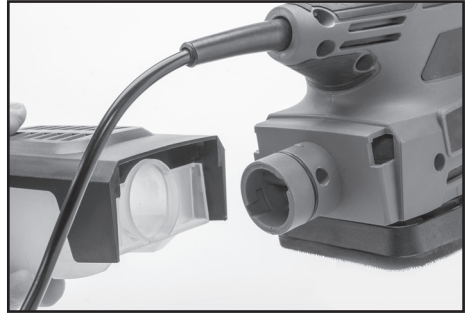

FIG.2



FIG.2

9. MAINTENANCE AND TROUBLESHOOTING

9.1 MAINTENANCE

Regular inspection and cleaning reduces the necessity for maintenance operations and will keep your tool in good working condition.

The motor must be correctly ventilated during tool operation. Avoid blocking the air inlets and vacuum the ventilation slots regularly.

9.2 TROUBLESHOOTING

Problem	Possible Cause	Remedy
Motor does not start.	<ol style="list-style-type: none">1. Fuse.2. Brushes worn.3. Other.	<ol style="list-style-type: none">1. 5 amp time delay fuse or circuit breaker.2. Have brushes replaced.3. Contact an authorised service centre.
Reduced sanding efficiency.	<ol style="list-style-type: none">1. Abrasive sheet worn, clogged or cracked.	<ol style="list-style-type: none">1. Replace abrasive sheet.†

10. OPTIONAL ACCESSORIES

10.1 OPTIONAL ACCESSORIES

A full range of accessory abrasive sheets are available from Draper Tools.

Please visit our website for details: www.drapertools.com

†Abrasive sheets and the base pad are both considered consumable items.

11. EXPLANATION OF SYMBOLS

11.1 EXPLANATION OF SYMBOLS



Read the instruction manual.



Wear face mask and safety glasses.



Wear ear defenders.



Wear protective gloves.



Long and loose hair must be contained or securely tied back.



Keep out of the reach of children.



Warning!



Single value noise marking.
(Maximum declared A-Weighted sound power level in decibels).



Class II construction
(Double insulated).



WEEE –
Waste Electrical &
Electronic Equipment.
Do not dispose of Waste Electrical & Electronic Equipment in with domestic rubbish.

12. DISPOSAL

12.1 DISPOSAL

- At the end of the machine's working life, or when it can no longer be repaired, ensure that it is disposed of according to national regulations.
- Contact your local authority for details of collection schemes in your area.

In all circumstances:

- Do not dispose of power tools with domestic waste.
- Do not incinerate.
- Do not dispose of WEEE* as unsorted municipal waste.



* *Waste Electrical & Electronic Equipment.*

NOTES

NOTES

NOTES

CONTACTS

Draper Tools Limited, Hursley Road,
Chandler's Ford, Eastleigh, Hampshire. SO53 1YF. U.K.

Help line: (023) 8049 4344

Sales Desk: (023) 8049 4333

Internet: drapertools.com

E-mail: sales@drapertools.com

General Enquiries: (023) 8026 6355

Service/Warranty Repair Agent:

For aftersales servicing or warranty repairs, please contact the
Draper Tools Help line for details of an agent in your local area.

YOUR DRAPER STOCKIST

TAKC1118

©Published by Draper Tools Limited.

No part of this publication may be reproduced, stored in a retrieval system or transmitted in any form or by any means, electronic, mechanical photocopying, recording or otherwise without prior permission in writing from Draper Tools Ltd.