



ARES 2

Installation instruction



1

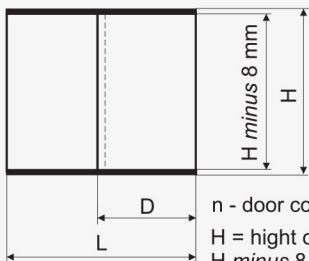

$$D = \frac{L + (n-1) \cdot z}{n}$$

n = 2,3,4....

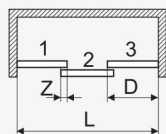

z - 40 mm
recommended

n - door count
H = height of the opening
H minus 8 mm = height of the door

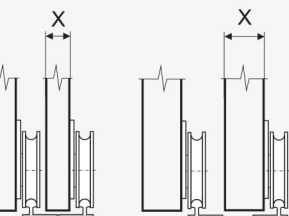

2 A

2 B

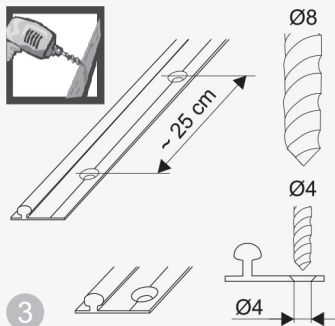

3



Ø3,5x16

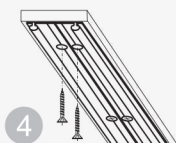

4



min. 30 mm

Ø4x16

5

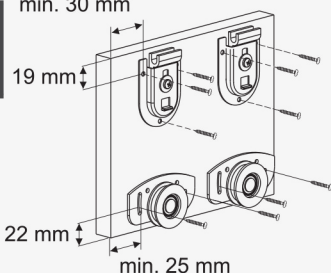

6

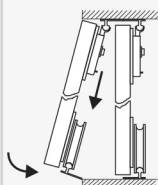

7

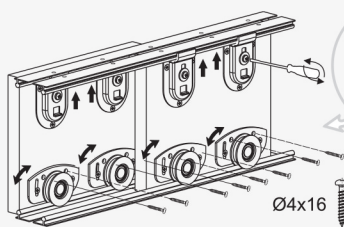

8

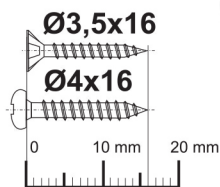
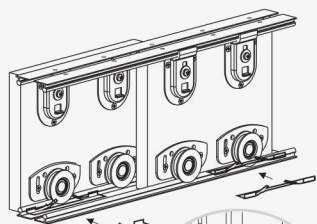
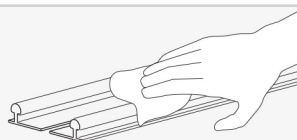

1:1