

evOLUTION®

www.evolutionpowertools.com

R210 MTS

Original Instructions

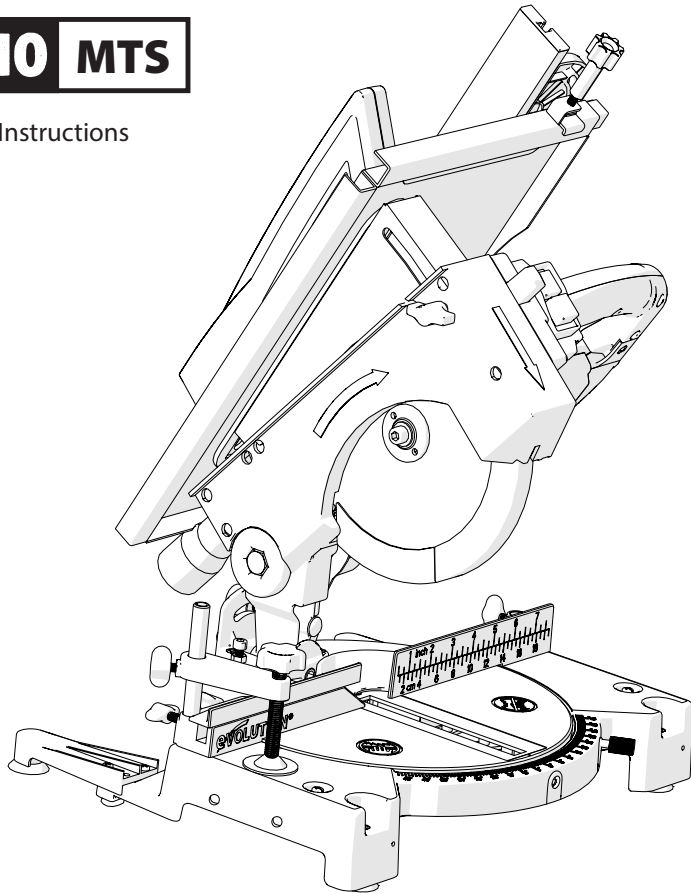

TABLE OF CONTENTS

INTRODUCTION	Page 3
Warranty	Page 3
Machine Specification	Page 4
Vibration	Page 5
Labels and Symbols	Page 6
Intended use of this Power Tool	Page 6
Prohibited use of this Power Tool	Page 6
SAFETY PRECAUTIONS	Page 7
Electrical Safety	Page 7
Outdoor Use	Page 7
General Power Tool Safety Instructions	Page 7
Additional Safety Instructions	Page 9
GETTING STARTED	Page 11
Unpacking	Page 11
Machine Overview	Page 13
Service Parts Diagram	Page 14
Assembly and Preparation	Page 15
Operating Instructions	Page 18
MAINTENANCE	Page 25
Environmental Protection	Page 30
DECLARATION OF CONFORMITY	Page 31

(1.3) IMPORTANT

Please read these operating and safety instructions carefully and completely.

For your own safety, if you are uncertain about any aspect of using this equipment please access the relevant technical helpline, the number of which can be found on the Evolution Power Tools website.

We operate several helplines throughout our worldwide organization, but technical help is also available from your supplier.

WEB: www.evolutionpowertools.com

EMAIL: customerservices@ept.com

WARRANTY

(1.4) Congratulations on your purchase of an Evolution Power Tools Machine. Please complete your product registration 'online' as explained on the leaflet included with this machine.

This will enable you to validate your machine's warranty period via Evolution's website by entering your details and thus ensure prompt service if ever needed.

We sincerely thank you for selecting a product from Evolution Power Tools.

SPECIFICATIONS

MACHINE	METRIC	IMPERIAL
Motor (230-240V~ 50 Hz)	1200W	5A
Speed No Load	3500min ⁻¹	3500rpm
Weight	9.45kg	20lb

CUTTING CAPACITIES	METRIC	IMPERIAL
Mild Steel Plate - Max. Thickness	3mm	1/8"
Mild Steel Plate - Max. Hardness	210HB	210HB

MAXIMUM CUTTING CAPACITY (ALUMINIUM, WOOD & PVC) MITRE SAW CONFIGURATION			
MITRE	BEVEL	MAX WIDTH OF CUT	MAX DEPTH OF CUT
90°	90°	115mm (4-1/2")	55mm (2-1/8")
45°	90°	65mm (2-1/2")	55mm (2-1/8")
45°	45°	40mm (1-9/16")	25mm (15/16")

MAXIMUM CUTTING CAPACITY - TABLE SAW CONFIGURATION		
CUTTING CAPACITIES	METRIC	IMPERIAL
Wood - Max Thickness	32mm	1-1/4"

BLADE DIMENSIONS	METRIC	IMPERIAL
Diameter	210mm	8-1/4"
Bore	25.4mm	1"
Number of Teeth	20	20
Kerf	1.7mm	1/16"

NOISE & VIBRATION DATA	
Sound Pressure L _{pA}	94.57dB(A) K=3dB(A)
Sound Power Level L ^{WA}	107.57dB(A) K=3dB(A)
Vibration Level	2.5m/s ² K=1.5m/s ²

(1.6) Note: The vibration measurement was made under standard conditions in accordance with: BS EN 61029-1:2009+A11.

The declared vibration total value has been measured in accordance with a standard test method and may be used for comparing one tool with another.

The declared vibration total value may also be used in a preliminary assessment of exposure.

(1.7) **VIBRATION**

WARNING: When using this machine the operator can be exposed to high levels of vibration transmitted to the hand and arm. It is possible that the operator could develop "Vibration white finger disease" (Raynaud syndrome). This condition can reduce the sensitivity of the hand to temperature as well as producing general numbness. Prolonged or regular users of this machine should monitor the condition of their hands and fingers closely. If any of the symptoms become evident, seek immediate medical advice.

- The measurement and assessment of human exposure to hand-transmitted vibration in the workplace is given in: BS EN ISO 5349-1:2001 and BS EN ISO 5349-2:2002.
- Many factors can influence the actual vibration level during operation e.g. the work surfaces condition and orientation and the type and condition of the machine being used. Before each use, such factors should be assessed, and where possible appropriate working practices adopted. Managing these factors can help reduce the effects of vibration:

Handling

- Handle the machine with care, allowing the machine to do the work.
- Avoid using excessive physical effort on any of the machines controls.
- Consider your security and stability, and the orientation of the machine during use.

Work Surface

- Consider the work surface material; its condition, density, strength, rigidity and orientation.







WARNING: The vibration emission during actual use of the power tool can differ from the declared total value depending on the ways in which the tool is used. The need to identify safety measures and to protect the operator are based on an estimation of exposure in the actual conditions of use (taking account of all parts of the operating cycle, such as the times the tool is switched off, when it is running idle, in addition to trigger time).

(1.8) **LABELS & SYMBOLS**

WARNING: Do not operate this machine if warning and/or instruction labels are missing or damaged. Contact Evolution Power Tools for replacement labels.

Note: All or some of the following symbols may appear in the manual or on the product.

(1.9) LABELS & SYMBOLS

Symbol	Description
V	Volts
A	Amperes
Hz	Hertz
Min ⁻¹	Speed
~	Alternating Current
n ₀	No Load Speed
	Wear Safety Goggles
	Wear Ear Protection
	Do Not Touch
	Wear Dust Protection
	Read Instructions
	CE certification
	Warning
	Waste electrical and electronic equipment
	Double Insulated

(1.10) INTENDED USE OF THIS POWER TOOL

WARNING: This product is a Hand Operated Compound Mitre Saw and has been designed to be used with special Evolution blades. Only use accessories designed for use in this machine and/or those recommended specifically by Evolution Power Tools Ltd.

When fitted with an appropriate blade this machine can be used to cut:

Mild Steel
Aluminium
Wood

(1.11) PROHIBITED USE OF THIS POWER TOOL

WARNING: This product is a Hand Operated Compound Mitre Saw and must only be used as such. It must not be modified in any way, or used to power any other equipment or drive any other accessories other than those mentioned in this Instruction Manual.

(1.13) WARNING: This machine is not intended for use by persons (including children) with reduced physical, sensory or mental capabilities, or lack of experience and knowledge, unless they have been given supervision or instruction concerning the safe use of the machine by a person responsible for their safety and who is competent in its safe use.

Children should be supervised to ensure that they do not have access to, and are not allowed to play with, this machine.

(1.14) ELECTRICAL SAFETY

This machine is fitted with the correct moulded plug and mains lead for the designated market. If the supply cord is damaged, it must be replaced by a special cord or assembly available from the manufacturers or its service agent.

(1.15) OUTDOOR USE

WARNING: For your protection if this tool is to be used outdoors it should not be exposed to rain, or used in damp locations.

Do not place the tool on damp surfaces.

Use a clean, dry workbench if available.

For added protection use a residual current device (R.C.D.) that will interrupt the supply if the leakage current to earth exceeds 30mA for 30ms. Always check the operation of the residual current device (R.C.D.) before using the machine.

If an extension cable is required it must be a suitable type for use outdoors and so labelled. The manufacturers instructions should be followed when using an extension cable.

(2.1) POWER TOOL GENERAL SAFETY INSTRUCTIONS

(These General Power Tool Safety Instructions are as specified in BS EN 60745-1:2009 & EN 61029-1:2009)

WARNING: Read all safety warnings and instructions. Failure to follow the warnings and instructions may result in electric shock, fire and/ or serious injury.

Save all warnings and instructions for future reference. The term "power tool" in the warnings refers to your mains-operated (corded) power tool or battery-operated (cordless) power tool.

(2.2) 1) General Power Tool

Safety Warnings [Work area safety]

a) Keep work area clean and well lit.

Cluttered or dark areas invite accidents.

b) Do not operate power tools in explosive atmospheres, such as in the presence of flammable liquids, gasses or dust. Power tools create sparks which may ignite the dust or fumes.

c) Keep children and bystanders away while operating power tool. Distractions can cause you to lose control.

(2.3) 2) General Power Tool Safety Warnings [Electrical Safety]

a) Power tool plugs must match the outlet.

Never modify the plug in any way. Do not use any adapter plugs with earthed (grounded) power tools. Unmodified plugs and matching outlets will reduce the risk of electric shock.

b) Avoid body contact with earthed or grounded surfaces, such as pipes, radiators, ranges and refrigerators.

There is an increased risk of electric shock if your body is earthed or grounded.

c) Do not expose power tools to rain or wet conditions. Water entering a power tool will increase the risk of electric shock.

d) Do not abuse the cord. Never use the cord for carrying, pulling or unplugging the power tool. Keep cord away from heat, oil, sharp edges or moving parts.

Damaged or entangled cords increase the risk of electric shock.

e) When operating a power tool outdoors, use an extension cord suitable for outdoor use. Use of a cord suitable for outdoor use reduces the risk of electric shock.

f) If operating a power tool in a damp location is unavoidable, use a residual current device (RCD) protected supply.

Use of an RCD reduces the risk of electric shock.

(2.4) 3) General Power Tool Safety Warnings [Personal Safety].

a) Stay alert, watch what you are doing and use common sense when operating a power tool. Do not use a power tool

while you are tired or under the influence of drugs, alcohol or medication. A moment of inattention while operating power tools may result in serious personal injury.

b) Use personal protective equipment.

Always wear eye protection. Protective equipment such as dust masks, non-skid safety shoes, hard hat or hearing protection used for appropriate conditions will reduce personal injuries.

c) Prevent unintentional starting. Ensure the switch is in the off-position before connecting to power source and or battery pack, picking up or carrying the tool. Carrying power tools with your finger on the switch or energising the power tools that have the switch on invites accidents.

d) Remove any adjusting key or wrench before turning the power tool on. A wrench or key left attached to a rotating part of a power tool may result in personal injury .

e) Do not overreach. Keep proper footing and balance at all times. This enables better control of the power tool in unexpected situations.

f) Dress properly. Do not wear loose clothing or jewellery. Keep your hair, clothing and gloves away from moving parts. Loose clothes, jewellery or long hair can be caught in moving parts.

g) If devices are provided for the connection of dust extraction and collection facilities, ensure that these are connected and properly used. Use of dust collection can reduce dust-related hazards.

(2.5) 4) General Power Tool Safety Warnings [Power tool use and care].

a) Do not force the power tool. Use the correct power tool for your application.

The correct power tool will do the job better and safer at a rate for which it was designed.

b) Do not use the power tool if the switch does not turn it on or off. Any power tool that cannot be controlled with the switch is dangerous and must be repaired.

c) Disconnect the power tool from the power source and/or battery pack from the power tool before making any adjustments, changing accessories, or storing power tools. Such preventative safety measures reduce the risk of starting the power tool accidentally.

d) Store idle power tools out of the reach of children and do not allow persons unfamiliar with the power tool or these instructions to operate the power tool.

Power tools are dangerous in the hands of untrained users.

e) Maintain power tools. Check for misalignment or binding of moving parts, breakage of moving parts and any other condition that may affect the power tools operation. If damaged, have the power tool repaired before use. Many accidents are caused by poorly maintained power tools.

f) Keep cutting tools sharp and clean.

Properly maintained cutting tools with sharp cutting edges are less likely to bind and are easier to control.

g) Use the power tool, accessories and tool bits etc. in accordance with these instructions, taking into account the working conditions and the work to be performed. Use of the power tool for operations different from those intended could result in a hazardous situation.

(2.6) 5) General Power Tool

Safety Warnings [Service]

a) Have your power tool serviced by a qualified repair person using only identical replacement parts. This will ensure that the safety of the power tool is maintained.

(2.7) HEALTH ADVICE

WARNING: When using this machine, dust particles may be produced. In some instances, depending on the materials you are working with, this dust can be particularly harmful. If you suspect that paint on the surface of material you wish to cut contains lead, seek professional advice. Lead based paints should only be removed by a professional and you should not attempt to remove it yourself. Once the dust has been deposited on surfaces, hand to mouth contact can result in the ingestion of lead.

Exposure to even low levels of lead can cause irreversible brain and nervous system damage. The young and unborn children are particularly vulnerable. You are advised to consider the risks associated with the materials you are working with and to reduce the risk of exposure. As some materials can produce dust that may be hazardous to your health, we recommend the use of an approved face mask with replaceable filters when using this machine.

You should always:

- Work in a well-ventilated area.
- Work with approved safety equipment, such as dust masks that are specially designed to filter microscopic particles.

(2.8) WARNING: the operation of any power tool can result in foreign objects being thrown towards your eyes, which could result in severe eye damage. Before beginning power tool operation, always wear safety goggles or safety glasses with side shield or a full face shield where necessary.

(3.5) ADDITIONAL SAFETY INSTRUCTIONS - MITRE SAWS

The following specific safety instructions for Mitre Saws are based on the requirements of EN61029-2-9:2009.

BLADE SAFETY

WARNING: Rotating Circular Saw Blades are extremely dangerous and can cause serious injury and amputation. Always keep fingers and hands at least 150mm away from the blade at all times. Never attempt to retrieve sawn material until the cutting head is in the raised position, the guard is fully closed and the saw blade has stopped rotating.

Only use saw blades that are recommended by the manufacturer and as detailed in this manual and that comply with the requirements of EN 847-1.

Do Not use saw blades that are damaged or deformed as they could shatter and cause serious injury to the operator or bystanders.

Do Not use saw blades that are manufactured from high speed steel (HSS).

If the table insert becomes damaged or worn it must be replaced with an identical one available from the manufacturer as detailed in this manual.

(3.6) PERSONAL PROTECTIVE EQUIPMENT (PPE)

Hearing protection should be worn in order to reduce the risk of induced hearing loss.

Eye protection should be worn in order to prevent the possibility of the loss of sight from ejected chippings.

Respiratory protection is also advised as some wood and wood type products especially MDF (Medium Density Fibreboard) can produce dust that can be hazardous to your health.

We recommend the use of an approved face mask with replaceable filters when using this machine in addition to using the dust extraction facility.

Gloves should be worn when handling blades or rough material. It is recommended that saw blades should be carried in a holder wherever practicable. It is not advisable to wear gloves when operating the mitre saw.

(3.7) SAFE OPERATION

Always ensure that you have selected the correct saw blade for the material being cut. Do Not use this mitre saw to cut materials other than those specified in this Instruction Manual.

When transporting a mitre saw ensure that the cutting head is locked in the 90 degree down position (if a sliding mitre saw ensure that the slide bars are locked). Lift the machine by gripping the outer edges of the base with both hands (if a sliding mitre saw, transport using the handles provided). Under no circumstances shall the machine be lifted or transported using the retractable guard or any part of its operating mechanism.

Before each use check the operation of the retractable guard and its operating mechanism ensuring that there is no damage, and that all moving parts operate smoothly and correctly.

Keep the work bench and floor area clear of all debris including sawdust, chips and off-cuts.

Always check and ensure that the speed marked on the saw blade is at least equal to the no load speed marked on the mitre saw.

Under no circumstances shall a saw blade be used that is marked with a speed that is less than the no load speed marked on the mitre saw.

Where it is necessary to use spacer or reducing rings these must be suitable for the intended purpose and only as recommended by the manufacturer.

If the mitre saw is fitted with a laser it shall not be replaced with a different type. If the laser fails to operate it shall be repaired or replaced by the manufacturer or his authorised agent. The saw blade shall only be replaced as detailed in this Instruction Manual.

Never attempt to retrieve off-cuts or any other part of the work piece until the cutting head is in the raised position, the guard is fully closed and the saw blade has stopped rotating.

(3.8) **PERFORM CUTS CORRECTLY & SAFELY**

Wherever practicable always secure the work piece to the saw table using the work clamp where provided.

Always ensure that before each cut the mitre saw is mounted in a stable position.

If needed the mitre saw can be mounted on a wooden base or work bench or attached to a mitre saw stand as detailed in this Instruction Manual.

Long work pieces should be supported on the work supports provided or on appropriate additional work supports.

(3.4) **WARNING:** If any parts are missing, do not operate your machine until the missing parts are replaced. Failure to follow this rule could result in serious personal injury.

(3.9) **ADDITIONAL SAFETY ADVICE CARRYING YOUR TABLE MITRE SAW**

Safety Advice

- **Although compact, this saw is heavy.**
To reduce the risk of back injury, get competent help whenever you have to lift the saw.
- **To reduce the risk of back injury, hold the tool close to your body when lifting.**
Bending your knees so you can lift with your legs, not your back. Lift by using the handhold areas at each side of the machines base.
- **Never carry the Table Mitre Saw by the power cord.** Carrying the tool by the power cord could cause damage to the insulation or the wire connections resulting in electric shock or fire.
- **Before moving the saw tighten the mitre and bevel locking screws to guard against sudden unexpected movement.**
- **Lock the Cutting Head in its lowest position.**
Ensure that the Cutting Head Locking Pin is completely engaged in its socket.

WARNING: Do not use the blade guard as a 'lifting point'. The power cord must be removed from the power supply before attempting to move the machine.

- Lock the Cutting Head in the down position using the Cutting Head locking pin.
- Loosen the Mitre Angle Locking Screw. Turn the table to either of its maximum settings.
- Lock the table in position using the Locking Screw.
- Use the two carry handle cut-outs machined into either side of the machine base, to transport the machine.

Place the saw on a secure stationary work surface and check the saw over carefully.

Check particularly the operation of all the machines safety features before attempting to operate the machine.

(4.1) **GETTING STARTED - UNPACKING**

Caution: This packaging contains sharp objects. Take care when unpacking. Remove the machine, together with the accessories supplied from the packaging. Check carefully to ensure that the machine is in good condition and account for all the accessories listed in this manual.

Also make sure that all the accessories are complete. If any parts are found to be missing, the machine and its accessories should be returned together in their original packaging to the retailer. Do not throw the packaging away; keep it safe throughout the guarantee period. Dispose of the packaging in an environmentally responsible manner. Recycle if possible. Do not let children play with empty plastic bags due to the risk of suffocation.

(4.2) ITEMS SUPPLIED

Description	Quantity
Instruction Manual	1
Hold Down Clamp	1
Push Stick	1
Pin Spanner (Blade Change)	1
Hex Key 6mm (Blade Change)	1
Hex Key 5mm (Riving Knife Adjustment)	1
Multi-Purpose Blade (Fitted)	1
Rip Fence/ Bevel Guide Assembly	1
Auxiliary Lower Blade Guard (Fitted)	1
Vacuum Adaptor Tube	1
Rear Stabilising Arms	2

(4.3) ADDITIONAL ACCESSORIES

In addition to the standard items supplied with this machine the following accessories are also available from the Evolution online shop at www.evolutionpowertools.com or from your local retailer.

(4.4)

Description	Part No
RAGE Multi-Material TCT Blade	RAGEBLADE210MULTI

R210MTS MITRE SAW CONFIGURATION

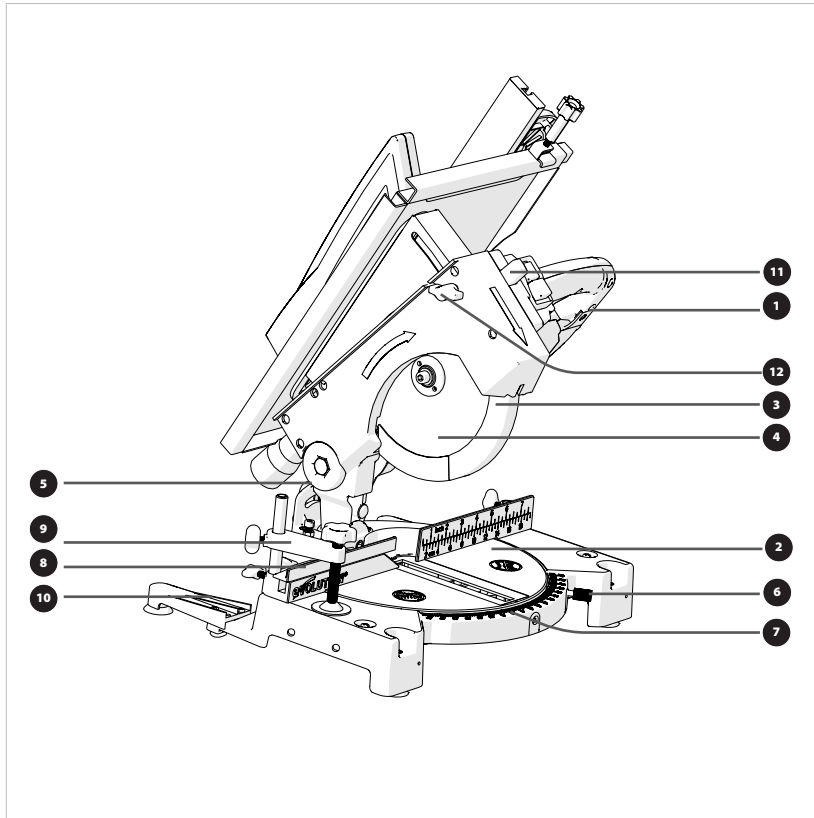

- | | |
|---|--|
| 1. CUTTING HANDLE | 7. MITRE ANGLE SCALE |
| 2. ROTARY TABLE | 8. ADJUSTABLE FENCE |
| 3. RETRACTABLE LOWER BLADE GUARD | 9. HOLD DOWN CLAMP |
| 4. BLADE | 10. STABILISING ARMS
(X2 Back of machine) |
| 5. BEVEL LOCKING LEVER
(Back of the machine) | 11. CUTTING HEAD RELEASE LEVER |
| 6. MITRE ANGLE LOCKING SCREW | 12. TABLE HEIGHT ADJUSTING SCREW |

R210MTS TABLE SAW CONFIGURATION

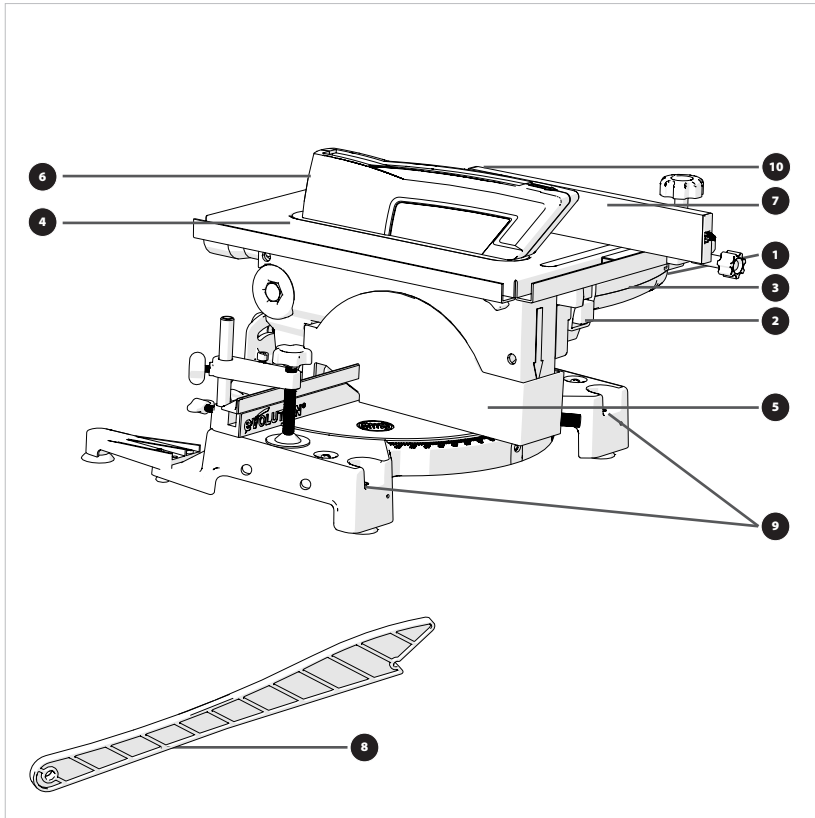

- | | |
|---|---|
| 1. ON/OFF TRIGGER SWITCH (Inside handle) | 7. RIP FENCE |
| 2. ON/OFF LATCHING SWITCHES | 8. PUSH STICK |
| 3. CUTTING HANDLE | 9. MOUNTING HOLE (2 at the front and 2 under the stabilising arms) |
| 4. TABLE TOP | 10. CUTTING HEAD LATCHING PIN (Not shown in this view) |
| 5. AUXILIARY LOWER BLADE GUARD | |
| 6. UPPER BLADE GUARD | |

GETTING STARTED

WARNING: ALWAYS DISCONNECT THE SAW FROM THE POWER SOURCE BEFORE MAKING ANY ADJUSTMENTS.

Refer to the "Service Parts Diagram". Install a blade as detailed in the "Installing or Removing the Blade" section.

Note: We recommend that the operator reads the 'Important Information' sticker applied to the table of the R210MTS. Practicing and becoming familiar with the procedures outlined on this sticker will make subsequent adjustments/assembly or configuring fairly straightforward.

PERMANENTLY MOUNTING THE R210MTS TABLE/ MITRE SAW (Fig. 1)

WARNING: To reduce the risk of injury from unexpected saw movement, place the saw in the desired location either on a workbench or other recommended leg set. The base of the saw has four holes to mount the mitre saw. If the saw is to be used in one location, permanently fasten it to the workbench or leg set using appropriate bolts with lock washers and nuts.

1. Tighten the mitre and bevel locks.
2. Position the saw so other people cannot stand behind it. Thrown debris could injure people in its path.
3. Place the saw on a firm, level surface where there is plenty of room for handling and properly supporting the workpiece.
4. Support the saw so that the table is level and the saw does not rock.
5. Bolt or clamp the saw to its support.

FOR PORTABLE USE (Fig. 2)

Note: The R210MTS is designed to be a highly portable machine.

For portable use the R210MTS must be fitted with the two (2) rear Stabilising Arms.

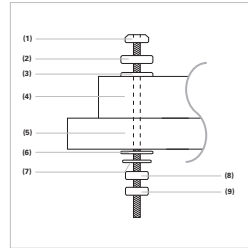

Fig. 1

- 1) Hex headed bolt
- 2) Spring washer
- 3) Flat washer
- 4) Mitre saw base
- 5) Workbench
- 6) Flat washer
- 7) Spring washer
- 8) Hex nut
- 9) Lock nut

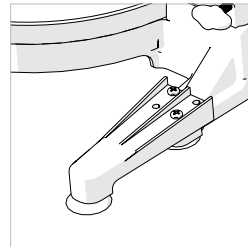

Fig. 2

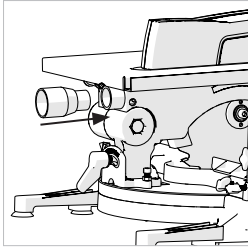

Fig. 3a

To fit the Stabilising Arms:

- Remove the cross head machine screws from the two (2) rear mounting positions.
- Attach the Stabilising Arms with the machine screws, two per arm and tighten securely.

Note: The Stabilising Arms are fitted with rubber feet. The base of the R210MTS is also fitted with four (4) identical rubber feet positioned underneath the mounting holes in the base.

When used as a portable machine the six (6) rubber feet provide the security and stability necessary for safe operation.

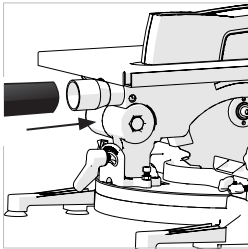

Fig. 3b
(Vacuum port, not supplied)

Note: When the machine is re-positioned the operator should ensure that none of the rubber feet become detached from the machine. The rubber feet can, in some circumstances, stick to some surfaces due to vacuum suction.

If any of the rubber feet become detached or damaged they must be replaced.

VACUUM PORT

A vacuum port (not supplied) can be fitted to the extraction port at the rear of the machine. **(Fig. 3a & 3b)**

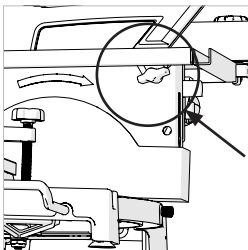

Fig. 4

- Push the adaptor tube into the extraction port at the rear of the machine.
- Slide the vacuum port onto the adaptor tube ensuring that the spring clip grips the tube holding the vacuum hose securely in place.

WARNING: DO NOT USE A VACUUM PORT WHEN CUTTING STEEL.

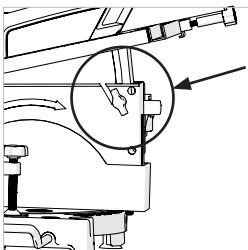

Fig. 5

TO CONFIGURE THE R210MTS FOR USE AS A MITRE SAW

WARNING: Only carry out this procedure with the machine disconnected from the power source.

Caution: The R210MTS has many built in safety features and safety interlocks. It is important that the following instructions, and those found on the label attached to the machine table are read, understood and acted upon. Failure to carry out the configuration procedure could result in damage to the machine and/or injury to the operator.

- Loosen the table height adjustment screw. **(Fig.4)**
- Raise the table top to its upmost position and tighten the height adjustment screw. **(Fig. 5)**
- Slightly push down on the Cutting Head Handle.
- Pull out the Cutting Head Latching Pin and allow the Cutting Head to rise to its upmost position. **(Fig. 6)**
- Remove the Auxiliary Lower Blade Guard and store safely for future use.

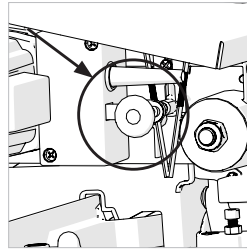

Fig. 6

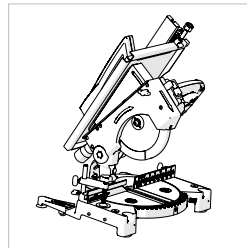

Fig. 7

The R210MTS is now ready to use as a Mitre Saw. **(Fig. 7)**

WORKPIECE SUPPORTS (Not Supplied) **(Fig. 8)**

Workpiece supports can be fitted to both sides of the machine base if required.

- Loosen the relevant Workpiece Retaining Screw located in a socket at the top front of the machine base.
- Insert the Workpiece Support into the holes machined in the base.

Note: The Workpiece Support should be pushed 'fully home' into the machine base.

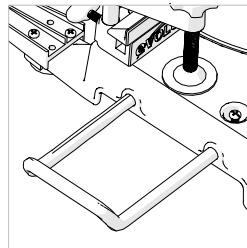

Fig. 8

Correct installation will require approximately 65mm of the Workpiece Support to slide into the machine base.

- Fasten the Workpiece Support into the base by tightening the Retaining Screw.

Workpiece Supports can be very useful in providing extra support for long workpieces when using the R210MTS in Mitre Saw configuration.

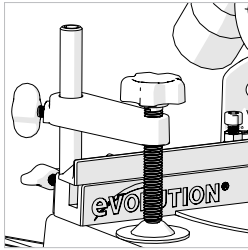

Fig. 9

HOLD DOWN CLAMP (Fig. 9)

A Hold Down clamp is supplied with the R210MTS.

Two sockets (one on either side) are incorporated into the rear of the machines fence.

- Fit the pillar of the clamp into the socket that best suits the cutting application, ensuring that it is pushed fully down.
- Tighten the fence thumbscrew to lock the pillar of the Hold Down Clamp into the fence socket.
- Put the workpiece onto the rotary table and against the fence.
- Adjust the Hold Down Clamp so that it securely holds the workpiece to the rotary table.
- Before attempting any cutting check to ensure that the clamp does not interfere with the blade path as the Cutting Head is lowered.

**OPERATING INSTRUCTIONS
MITRE SAW CONFIGURATION**

WARNING: It is important that the operator is adequately trained in the use, adjustment and operation of the machine, and has read the Instruction Manual before commencing operations.

Note: We recommend that when the R210MTS is being used as a Mitre Saw, the complete Fence Assembly is removed from the machine as stored safely for future use.

1. Releasing the Cutting Head

Note: When configured in Mitre Saw mode the Cutting Head will be automatically locked in its upper position with the Retractable Lower Blade Guard completely covering the blade teeth.

To release the Cutting Head press and hold the Cutting Head Release Lever.

Gently press down on the Cutting Head Handle to lower the Cutting Head. The operation of the Retractable Lower Blade Guard is automatic.

Note: We recommend that when the machine is not in use the Cutting Head is locked in its down position, with the Auxiliary Lower Blade Guard correctly installed and the Cutting Head Latching Pin fully engaged in its socket.

2. Preparing to make a cut

- Avoid awkward operations and hand positions where a sudden slip could cause fingers or hands to move into the blade.
- Cut only one workpiece at a time.
- Clear everything except the workpiece and related support devices away from the blade before commencing operations.
- Fasten the workpiece using clamp(s) to hold the workpiece securely to the table and fence.

3. Body and Hand position (Fig. 10)

- Never place hands within the 'no hands zone' (at least 150mm away from the blade). Pictograms on the machines rotary table are provided as an aid to safe working practices. Keep hands away from the path of the blade.
- Hold the workpiece firmly to prevent any movement. Use a Hold Down Clamp if possible but check that it is positioned that it does not interfere with the path of the blade or other moving machine parts.
- Before attempting a cut, make a 'dry run' with the power off so that you can see the path of the blade.
- Keep hands in position until the ON/OFF trigger has been released and the blade has completely stopped.

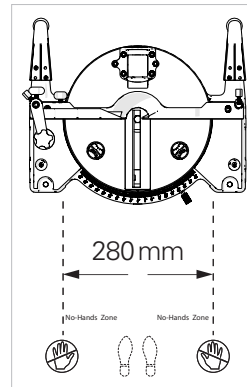

Fig. 10

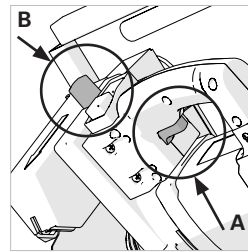

Fig. 11a + 11b

4. The Mitre Saw On/Off Trigger Switch Operation (Fig. 11a)

The On/Off Switch is a non-latching trigger type switch which is ergonomically located on the inside of the Cutting Head Handle.

Operate the switch to turn on the machines motor. Release the switch to turn off the machines motor.

Note: The Cutting Head cannot be lowered until the Cutting Head Release Lever is operated. (Fig. 11b) The Blade will remain covered by the retractable guard until the Cutting Head is released. Operation of the Retractable Guard is automatic.

5. Chop Cutting

The Cutting Head is gently pushed down to cut through the workpiece.

- Place the workpiece on the Rotary Table and against the fence in the desired position. Secure with clamp(s) as appropriate.
- Grasp the Cutting Handle.
- Turn on the motor using the trigger switch and allow the blade to reach full operating speed.
- Press and hold the Cutting Head Release Lever to release the Cutting Head.
- Gently lower the Cutting Head to its lowest position, cutting through the workpiece.

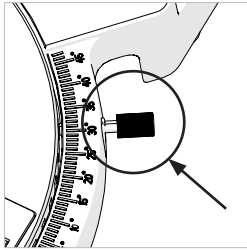

Fig. 12

- After the cut is completed, turn off the motor by releasing the trigger switch. Allow the blade to come to a complete stop. Allow the Cutting Head to rise to its upper position.
- Only remove your hands or the workpiece from the machine when the Cutting Head is in its upper position with the blade teeth completely covered by the Retractable Blade Guard.

6. Mitre Cutting

Any angle from 45° left to 45° right is available, and a protractor scale can be found to the front of the Rotary Table.

Positive stops are provided for every 5° of angular movement.

Note: The rotary table must always be locked into position with the Mitre Angle Locking Screw even if a positive stop is selected.

To select a Mitre Angle:

- Loosen the Mitre Angle Locking Screw. **(Fig.12)** This is found at the front RH side of the table near the 30° index mark.
- Turn the Rotary Table to the required angle. To aid setting, an index mark is machined into the table just in front of the table insert.
- Tighten the Mitre Angle Locking Screw securely when the desired angle has been selected.

A Mitre Cut can now be made using the same techniques as previously described in Chop Cutting.

7. Bevel Cutting

The Cutting Head can be set at any angle up to 45° to the Left Hand side only.

The Bevel Locking Lever is found at the rear of the machine. A protractor guide and pointer are incorporated into the bevel mechanism to aid setting. **(Fig.13)**

To set a Bevel Angle:

- Loosen the Bevel Lock Handle
- Tilt the Cutting Head to the desired angle. Use the protractor guide to aid with setting.
- Ensure that the Bevel Lock Handle is securely tightened when the desired angle has been achieved.

A Bevel Cut can now be made using the same techniques as previously outlined.

Note: Always make a 'dry run' with the machine switched 'off'

so that the path of the blade can be checked. Some Bevel and Compound Cuts may require the Hold Down Clamp to be positioned to the RH side of the Cutting Head. This may be necessary to avoid interference with the blade and other parts of the machine as the Cutting Head is lowered.

8. Fence Adjustment

Note: The left hand side of the fence is provided with additional adjustments. The upper portion of the fence can slide to the left to provide clearance for the blade. This may be necessary when acute bevel angles are selected.

Before making a compound cut, remove the upper portion of the fence completely.

To adjust the fence:

- Loosen the thumbscrew. (**Fig 14a**)
- Slide the upper portion of the fence to the required position and tighten the thumbscrew.
- Lower the Cutting Head to check the path of the blade. Ensure there is no interference with any other parts of the machine.

To remove the fence:

Note: This is only necessary when performing compound cuts.

- Loosen the thumbscrew (2-3 full turns) (**Fig 14a**).
- Loosen the machine screw (**Fig 14b**) with the supplied M5 hex key.
- Slide the upper portion of the fence out of the lower fence completely. Store in a safe place for refitting later.
- Lower the Cutting Head to check the path of the blade. Ensure there is no interference with any other parts of the machine.
- To refit the fence, reverse the previous steps.

9. Compound Cutting

A Compound Cut is a combination of a Mitre Cut and Bevel Cut.

- Set the Mitre Angle required as previously described.
- Set the Bevel Angle as previously described.
- Ensure the tightness of all adjustment/locking screws, and conduct a 'dry run' to check the path of the blade.
- Make the cut as previously described.

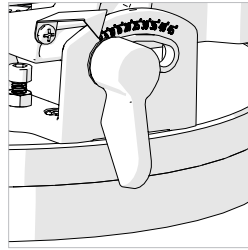

Fig. 13

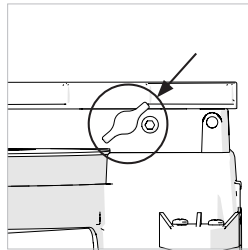

Fig. 14a

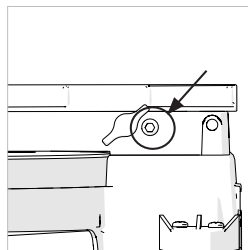

Fig. 14b

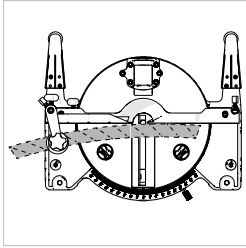

Fig. 15

10. Cutting Bowed Material (Fig 15)

Before cutting any workpiece, check to see if it is bowed. If it is bowed the workpiece must be positioned and cut as shown. Do not position the workpiece incorrectly or cut the workpiece without the support of the fence.

11. Clearing Jammed Material

- Turn mitre saw "OFF" and allow the blade to come to a complete halt.
- If possible allow the Cutting Head to rise to its upper position.
- Unplug the Mitre Saw from the mains supply.
- Carefully remove any jammed material from the machine.

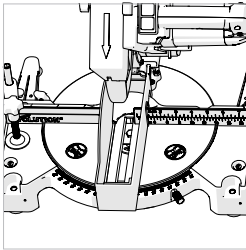

Fig. 16

TO CONFIGURE THE R210MTS FOR USE AS A TABLE SAW

WARNING: Do not cut metal or metallic materials when the machine is configured as a Table Saw.

WARNING: Only carry out this procedure with the machine disconnected from the power supply.

Caution: The R210MTS has many built in safety features and safety interlocks. It is important that the following instructions, and those found on the label attached to the machine table are read, understood and acted upon. Failure to carry out the configuration procedure could result in damage to the machine and/or injury to the operator.

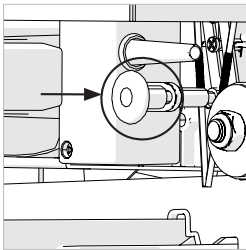

Fig. 17

- Ensure that the Rotary Table is set at 0° Mitre angle and the Cutting Head is set at 0° Bevel angle.
- Position the Auxiliary Lower Blade Guard on the Rotary Table over the table insert and straddling the Fence. **(Fig. 16)**
- Lower the Cutting Head to the fully down position, capturing the Lower Auxiliary Blade Guard. Push the Cutting Head Latching Pin into its socket. **(Fig. 17)**
- Loosen the Table Height Adjustment Screw **(Fig.18)** and lower the table to its lowest position.
- Tighten the Height Adjustment Screw.

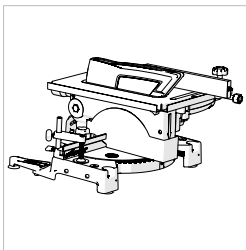

Fig. 18

The R210MTS is now ready to use as a Table Saw.

FENCE ASSEMBLY (Fig. 19)

The Fence Assembly consists of two (2) main parts:

- The Angle Gauge.
- The Rip Fence Face Plate.

Note: The 'T' slot in the Rip Fence Face Plate is not centrally located.

- Slide the Rip Fence Face Plate onto the two (2) mounting screws found on the Angle Plate.
- Ensure that the wider (20mm) portion of the Fence Face is downwards and will lie on the saw table when in use.

The Angle Plate can now be slid into the Rip Fence channel found at the front of the machine table. **(Fig. 20)**

Slide in from the Right Hand side ensuring that the Locking Clamp engages correctly with the front face of the Rip Fence channel.

FENCE ASSEMBLY AS A RIP FENCE

To use the Fence Assembly as a Rip Fence the Face Plate must be accurately aligned with the blade.

WARNING: Only carry out this procedure with the machine disconnected from the power supply.

To Align the Rip Fence:

- Ensure that the table is at its lowest setting (see Fig. 23a & 23b)
- Set the Angle Gauge to an indicated 90°.
- Slide the Fence Assembly up to the blade, raising the Blade Guard by hand so that the Face Plate rests alongside the blade and underneath the Blade Guard. **(Fig.21)**
- Gently tighten the Angle Gauge Locking Clamp Screw to lock the Assembly into the Rip Fence channel.
- Check that the Face Plate is in exact alignment with the blade.
- If adjustment is required, loosen slightly the Angle Clamping Screw and adjust the Angle Gauge until exact alignment is achieved.
- Tighten the Angle Clamping Screw.
- Adjust the Angle Gauge Pointer if necessary to point exactly to the 90° index mark.
- Use a #2 Phillips Head screwdriver to loosen the Angle Pointer fixing screw. **(Fig. 22)** Adjust the pointer to suit and then retighten the fixing screw.
- Loosen the Angle Clamp Locking Screw to allow the Assembly to slide along the Rip Fence channel.

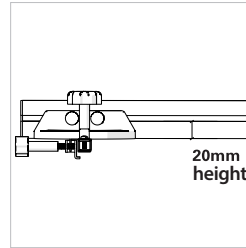

Fig. 19

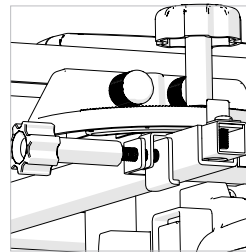

Fig. 20

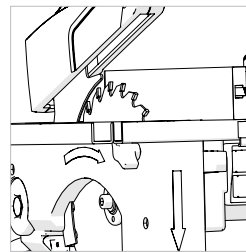

Fig. 21

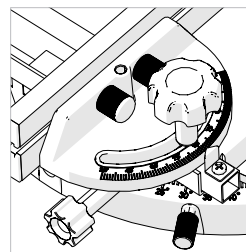

Fig. 22

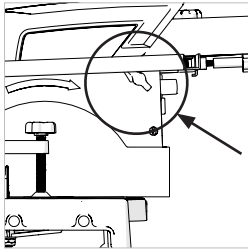

Fig. 23a

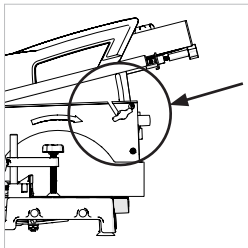

Fig. 23b

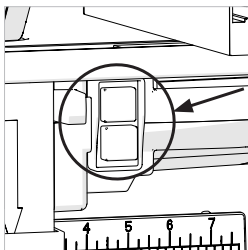

Fig. 24

BASIC TABLE SAW OPERATIONS

WARNING: Do not cut metal or metallic materials when the machine is configured as a Table Saw.

WARNING: Never attempt freehand cuts on this machine. Always use a correctly adjusted Rip Fence to minimise the possibility of the blade binding and kickback.

1. Adjusting the Table Height (Fig. 23a & 23b)

The height of the Table above the machines motor can be adjusted. This enables your R210MTS to mimic the rise and fall facility found on many conventional table saws. The cutting depth of the blade can thereby be adjusted from 0mm to 32mm.

WARNING: Only adjust the height of the table with the machine disconnected from the mains power supply.

To adjust:

- Loosen the Height Adjustment Screw and adjust the table height so that the saw blade protrudes through the table by the required amount. Retighten the screw.
- We recommend that the saw blade protrudes through the material to be cut by approximately 3mm.

WARNING: This machine is not suitable for cutting rebates or stopped grooves.

Note: A workshop dust extraction device can be connected to the extraction port found at the rear of the machine if required.

2. Table Saw On/Off Switches (Fig. 24)

The On/Off Switch is a two (2) button latching type. The buttons are located on the Front Left Hand side of the Cutting Handle.

- Push the Green (I) button to start the motor.
- Push the Red (O) button to stop the motor.

3. Rip cutting

Note: The R210MTS in Table Saw mode is optimally suited for the cutting of thin sheet material such as laminate flooring etc.

Rip cutting is cutting along the length of a piece of material rather than across it.

Rip cutting should always be done with the Rip Fence set to the desired width and on the RH side of the machines table.

Note: Check that the Rip Fence is locked in position and is parallel to the saw blade. Check that the riving knife is properly aligned with the saw blade.

When ripping small section material a Push Stick should be used to feed/guide the final 300mm of the material past the blade. A Push Stick should always be used when making cuts of less than 300mm.

Note: A Push Stick (**Fig. 25**) is provided with the R210MTS and has a dedicated storage position to the front of the machine.

We recommend that when not in use the Push Stick is stored on the machine.

When ripping long boards or large panels always use a remote work support or enlist competent trained help.

Feed the workpiece through the saw keeping it indexed against the Rip Fence. Use smooth, steady pressure and employ a Push Stick when necessary.

Hands should never be in line with the blade.

MAINTENANCE AND ADJUSTMENTS

WARNING: Ensure that the machine is disconnected from the mains supply before any maintenance tasks or adjustments are attempted.

Cleaning

After each use the machine should be cleaned. Remove all sawdust etc from the visible parts of the machine with a vacuum cleaner. A vacuum cleaner can also be connected to the machine dust extraction port at the rear of the machine. This should remove debris from the inside of the machine. Never use solvents to clean plastic parts, as solvents can damage them. Clean only with a soft slightly damp cloth.

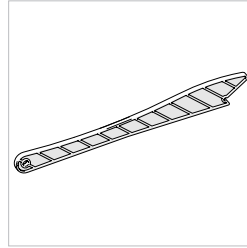

Fig. 25

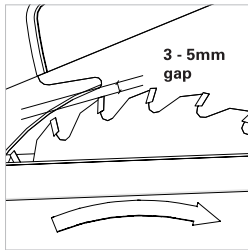

Fig. 26

Riving Knife

The Riving Knife is a very important component and comes factory fitted and correctly aligned and adjusted. The Riving Knife prevents the work from binding as it passes through the blade. Inspect the Riving Knife at regular intervals and replace it if it is worn or damaged.

The Riving Knife should be adjusted so that the gap between the tips of the blade teeth and the edge of the Riving Knife is approximately 3-5mm. **(Fig.26)**

To adjust the Riving Knife loosen the two (2) fixing screws **(Fig. 27)** slightly using an allen key. When correct alignment is achieved tighten the fixing screws.

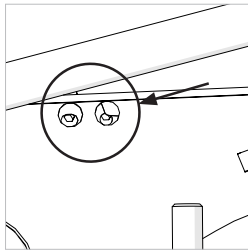

Fig. 27

Note: Use only a genuine Evolution Riving Knife, as this is a dedicated component for this machine. Non genuine parts could be dangerous. If in any doubt, please contact the Helpline.

Push Stick

A plastic push stick is provided with the machine. When not in use store the push stick on the machine.

Note: If the push stick becomes damaged it should be replaced. If the operator makes their own push stick, we recommend that it follows the same pattern as that supplied. Replacement push sticks are available from Evolution Power Tools.

INSTALLING or REMOVING a BLADE

WARNING: Only use genuine Evolution blades which are designed for use in this machine. Ensure that the maximum speed of the blade is compatible with the machine. Only perform this operation with the machine disconnected from the mains supply.

Note: It is recommended that the operator considers wearing protective gloves when handling the blade during installation or when changing the machines blade.

Note: The blade is a very precise fit within the R210MTS machine. Be patient and methodical when changing the blade.

To change a blade:

- Ensure that the machine is in Mitre Saw Mode with the Cutting Head in its upper position.
- Release the Retractable Lower Guard Operating Lever by removing and safely storing its pivot screw. **(Fig. 28)**
- Use the pin spanner (provided) to hold the outer blade flange.
- Use the hex key (provided) to unscrew the arbor screw. **(Fig. 29)**

Note: The arbor screw has a Left Hand thread. Turn clockwise to undo and counterclockwise to tighten.

- Remove the arbor screw, washer and outer blade flange.
- Manually operate the Lower Blade Guard and retract it fully up into the body of the machine
- Remove the blade by withdrawing it outwards to clear the end of the arbor and then downwards and forwards away from the machine.

Note: The 5mm blade slot at the lower front of the Cutting Head **(Fig. 30)** provides extra clearance when manoeuvring the blade into or out of the machine.

To refit:

- Ensure that the blade is suitable for this machine.
- Ensure that the direction of rotation arrow on the blade matches the direction of rotation arrow found on the machines Side Blade Guard. The blade teeth should always point downward at the front of the saw.
- Using the blade slot to provide maximum clearance and access to the machine, carefully and gently manoeuvre the blade up into the machine and locate it on the inner blade flange.
- Reinstall the outer blade flange, washer and arbor screw.
- Hand tighten the assembly.
- Hold the outer blade flange with the pin spanner.
- Tighten the arbor screw with the hex key.
- Check that the blade spins freely by rotating it by hand.
- Close the Retractable Blade Guard around the blade so the blade teeth are completely covered.
- Re-connect the Retractable Blade Guard Operating Lever to its service position using the pivot screw.
- Check the installation, particularly for the operation of all the safety guards.

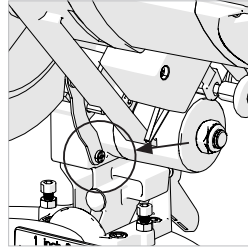
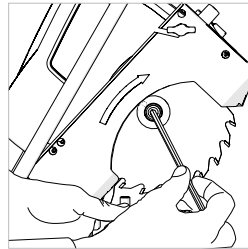
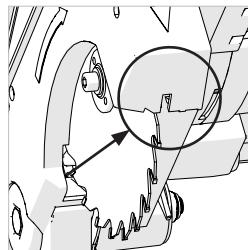
**Fig. 28****Fig. 29****Fig. 30**

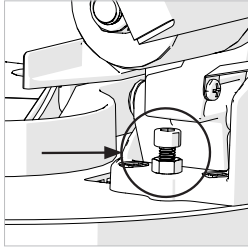

Fig. 31

CHECKING AND SETTING OF BEVEL ANGLES

WARNING: Before making any adjustments ensure that the machine is disconnected from the power supply.

Note: While all angular settings have been factory set, checking and adjustment may be required as a consequence of normal operational wear and tear.

Note: To check and adjust the Bevel Angles the machine must be in Mitre Saw configuration.

0° BEVEL ANGLE

At 0° Bevel Angle the blade should be perpendicular and at exactly 90° to the Rotary Table. An accurate engineers square (not supplied) is needed to check the 0° Bevel Angle.

To check:

- Ensure that the Cutting Head is in the vertical position, against its stop with the Bevel Pointer indicating 0° Bevel Angle.
- Tighten the Bevel Lock Handle.
- Lower the Cutting Head to its lowest position. The Retractable Lower Blade Guard will rotate up into the machine.
- The engineers square can now be used to check the angle between the blade and the Rotary Table.

If adjustment is required:

Note: The Cutting Head will need to be tilted to gain access to the 0° Bevel Stop Adjustment Screw.

- Loosen slightly the 0° Bevel Stop Adjustment Screw locknut. **(Fig. 31)**
- Use an Allen Key to turn the Bevel Stop Screw clockwise or counterclockwise as required.
- When exact alignment between the blade and Rotary Table is achieved, tighten the locknut.

45° BEVEL ANGLE

The 45° Bevel Angle can be checked in a similar manner to the 0° Bevel Angle. An accurate 45° Engineers Set Square (not supplied) will be required.

To check:

- Ensure that the Cutting Head is tilted to the 45° position, against its stop, with the Bevel Pointer indicating 45° Bevel Angle.
- Tighten the Bevel Lock Handle.
- Lower the Cutting Head to its lowest position. The Retractable Lower Blade Guard will rotate up into the machine.
- Use the Engineers 45° Set Square to check the angle of between the blade and the Rotary Table.

If adjustment is required:

Note: The Cutting Head will need to be tilted to gain access to the 45° Bevel Stop Adjustment Screw.

- Loosen slightly the 45° Bevel Stop Adjustment Screw locknut. **(Fig. 32)**
- Use a Hex Key to turn the Bevel Stop Screw clockwise or counterclockwise as required.
- When exact alignment between the blade and Rotary Table is achieved, tighten the locknut.

FENCE ADJUSTMENT (Fig. 33a & 33b)

The Fence is fastened to the machines base by two (2) socket head screws, one on either side. These Screws are located in elongated holes, which enable the Fence to be repositioned as required.

The Fence should be set at exactly 90° to a correctly installed blade.

An accurate Engineers Square (not supplied) will be required to precisely position the Fence.

To reposition the Fence:

- Set the Rotary Table to 0° Mitre Angle.
- Set the Cutting Head to 0° Bevel Angle.
- Slightly loosen the two (2) Fence socket head screws.
- Lower the Cutting Head to its lowest position.
- Check the alignment of the Fence with the Blade using the Engineers Square.
- Align the Fence as necessary and then tighten the socket head screws.

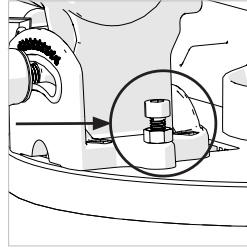

Fig. 32

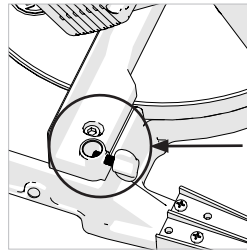

Fig. 33a

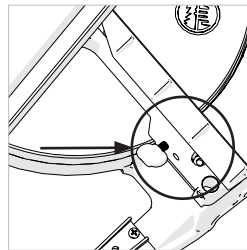
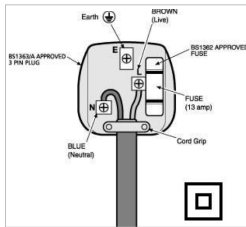

Fig. 33b



FUSE AND PLUG REPLACEMENT (230V Only)

Should the fuse in the main plug of your machine need replacing it should always be replaced with one of identical rating.

Check the voltage given on your machine matches the supply voltage.

This machine is supplied with a fitted moulded plug. If you should need to fit a new plug follows the protocol below.

IMPORTANT

The wire in the mains lead are coloured in accordance with the following code:

- Blue --- Neutral
- Brown --- Live

The wire that is coloured blue must be connected to the terminal that is marked with the letter N. The wire that is coloured brown must be connected to the terminal that is marked with the letter L.

A 13AMP (BS1363 or BS1363/A) plug must be used and a 13 AMP fuse must be fitted.

ENVIRONMENTAL PROTECTION

Waste electrical products should not be disposed of with household waste. Please recycle where facilities exist. Check with your Local Authority or retailer for recycling advice.



EC DECLARATION OF CONFORMITY

In accordance with EN ISO 17050-1:2004



The manufacturer of the product covered by this Declaration is:

UK: Evolution Power Tools Ltd. Venture One, Longacre Close, Holbrook Industrial Estate, Sheffield, S20 3FR.

FR: Evolution Power Tools SAS. 61 Avenue Lafontaine, 33560, Carbon-Blanc, Bordeaux, France.

The manufacturer hereby declares that the machine as detailed in this declaration fulfils all the relevant provisions of the Machinery Directive and other appropriate directives as detailed below. The manufacture further declares that the machine as detailed in this declaration, where applicable, fulfils the relevant provisions of the Essential Health and Safety requirements.

The Directives covered by this Declaration are as detailed below:

2006/42/EC.	Machinery Directive.
2014/30/EU.	Electromagnetic Compatibility Directive
2011/65/EU. & 2015/863/EU.	The Restriction of the Use of certain Hazardous Substances in Electrical Equipment (RoHS) Directive
2002/96/EC as amended by 2003/108/EC.	The Waste Electrical and Electronic Equipment (WEEE) Directive.

And is in conformity with the applicable requirements of the following documents:

EN 61029-1 • EN 61029-2-11 • EN 55014-1 • EN 55014-2 • EN 61000-3-2 • EN 61000-3-3

Product Details

Description: R210MTS 210mm MULTI-MATERIAL TABLE/MITRE SAW
Evolution Model No: 067-0006, 067-0006A, 067-0007, 067-0007A, 067-0008, 067-0008A
Brand Name: EVOLUTION
Voltage: 230-240V~ 50Hz
Input: 1200W

The technical documentation required to demonstrate that the product meets the requirements of directive has been compiled and is available for inspection by the relevant enforcement authorities, and verifies that our technical file contains the documents listed above and that they are the correct standards for the product as detailed above.

Name and address of technical documentation holder.

Signed:  Print: Barry Bloomer
Supply Chain & Procurement Director
Date: 05.02.18

UK: Evolution Power Tools Ltd. Venture One, Longacre Close, Holbrook Industrial Estate, Sheffield, S20 3FR.
FR: Evolution Power Tools SAS. 61 Avenue Lafontaine, 33560, Carbon-Blanc, Bordeaux, France.

evOLUTION®

evolutionpowertools.com

AUS

Total Tools (Importing) Pty Ltd
20 Thackray Road
Port Melbourne
Vic 3207

T: 03 9261 1900

FR

Evolution Power Tools SAS
61 Avenue Lafontaine
33560, Carbon-Blanc
Bordeaux

T: +33 (0)5 57 30 61 89

UK

Evolution Power Tools Ltd
Venture One, Longacre Close
Holbrook Industrial Estate
Sheffield, S20 3FR

T: +44 (0)114 251 1022

USA

Evolution Power Tools LLC
8363 Research Drive
Davenport, IA
52806

T: 833-MULTI-SAW (Toll Free)

DE +44 (0)114 251 1022

ES +34 91 114 73 85

NL +44 (0)114 251 1022

PL +48 33 821 0922

PT +34 91 114 73 85

RO +44 (0) 114 2050458

RU +7 499 350 67 69

TR +90 (0) 312 9001810

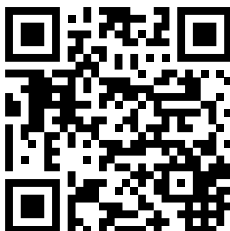

EPT QR CODE