

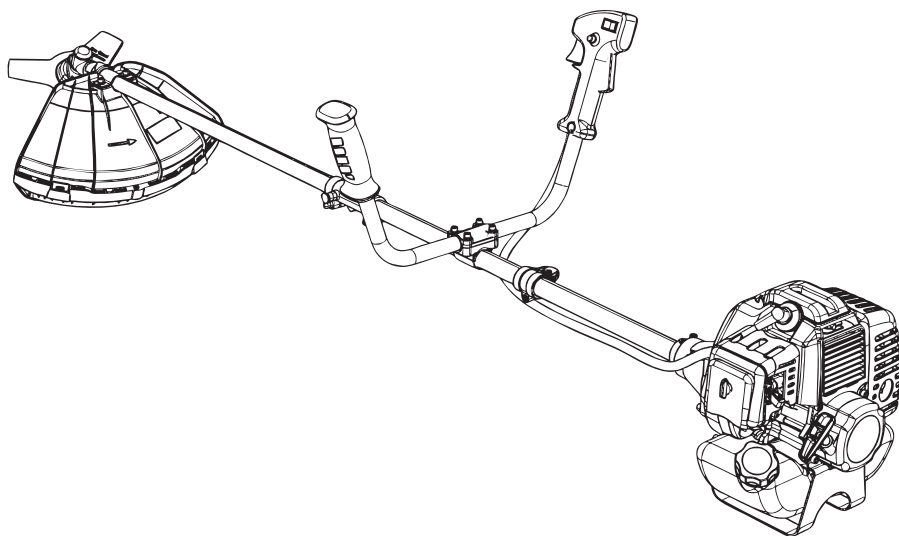

Original User's Instructions

52cc Brush cutter

SKU: 66933



READ BEFORE USE

PLEASE KEEP THESE INSTRUCTIONS FOR FURTHER REFERENCE

CONTENT

• WHAT'S IN THE BOX -----	3
• SPECIFICATIONS -----	4
• EXPLANATIONS AND SYMBOLS, CAUTIONS AND WARNINGS -----	5
• IMPORTANT SAFETY WARNINGS -----	7
• PRODUCT DESCRIPTION AND IDENTIFICATIONS -----	13
• ASSEMBLY AND OPERATING INSTRUCTIONS -----	14
• CARE AND CLEANING -----	27
• TROUBLE SHOOTING -----	34
• DECLARATION OF CONFORMITY / PERFORMANCE -----	35
• ENVIRONMENTAL INFORMATION -----	36
• GUARANTEE -----	37
• CUSTOMER SUPPORT -----	37

WHAT'S IN THE BOX

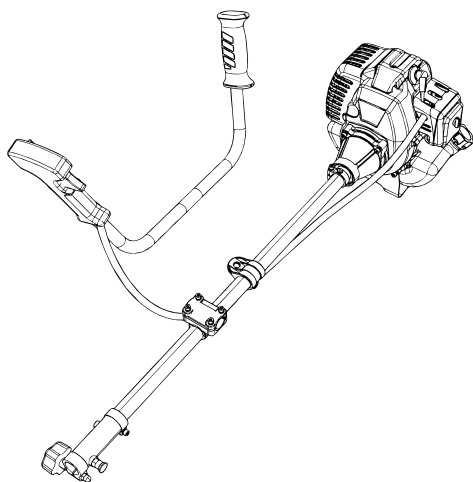

Main unit

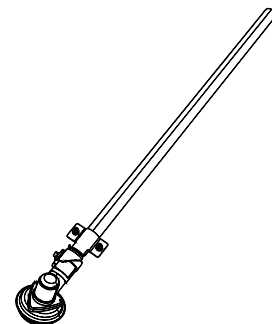

Shaft



Hex key 5mm



Hex key 4mm

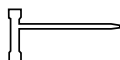

Socket wrench/
slotted screwdriver



Screw driver



Wrench



Guard



Spool



Blade



Double shoulder harness

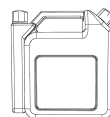

Fuel mixing bottle

If you do not have all these items, please contact:

www.coreservice.co.uk

Hotline: +44 01904 947568

Email support@coreservice.co.uk

SPECIFICATION

- 48cm cutting diameter (spool)
- 25.5cm cutting diameter (blade)
- 9000 RPM maximum engine speed (blade)
- 8000 RPM maximum engine speed (spool)
- Aluminium shaft
- 2x2m line length

Technical Data	
Property	Value
Engine type	Single-cylinder, 2-stroke
Displacement (cc)	52cc
Engine power	1.4kW
Tank capacity	1200ml
Idle speed	3100±400min ⁻¹
Clutch engaged speed	4500min ⁻¹
Ignition	C.D.I
Cutting width - grass trimmer	480mm
Cutting width - brush cutter	255mm
Diameter of cutting line	Ø2.4mm
Net weight approx.	7.5kg
Sound pressure level L _{PA} (dB)	99 dB(A) K=3 dB(A)
Sound power level L _{WA} (dB)	114 dB(A) K=3 dB(A)
Guaranteed sound power level L _{WA} (dB)	114 dB(A)
Vibration (m/s ²)	8.3m/s ² K=1.5m/s ²
Spark type	L8RTF
Maximum rotational frequency of the spindle	6800 (brush cutter)min ⁻¹ 6000 (grass trimmer)min ⁻¹

EXPLANATIONS AND SYMBOLS, CAUTIONS AND WARNINGS



Read the instructions and following warnings and safety instructions.



Wear eye and hearing protection (PPE). Where this is a risk of falling objects, wear head protection.



Wear protective gloves.



Wear slip-resistant footwear.



When working, the distance between the machine and bystanders shall be at least 15m.



Maximum permitted rotational speed of the cutting tool.



Warning! Hot surface - Burns to fingers or hands.



The product complies with the applicable European directives and an evaluation method of conformity for these directives was done.



UK Conformity Assessed



Guaranteed sound power level data (114dB), in accordance with Directive 2000/14/EC.



Beware of thrown objects.



Beware of blade thrust!



Maximum permitted rotational speed of the cutting blade.



'I' means ON
'O' means OFF



Choke. Move choke lever to 'RUN' position. See Starting and Stopping Engine Section.



Choke. Move choke lever to 'CHOKE' position. See Starting and Stopping Engine Section.



Beware of thrown objects



Caution! Risk of injury due to running blades!



Wear respiratory protection.



Caution! Risk of suffocation!



The machine shall not be used in any position that causes any part to come within 10 m of overhead electrical lines.



No naked flame

IMPORTANT SAFETY WARNINGS

General safety



WARNING! Read all safety warnings and instructions.

Failure to follow the warnings and instructions may result in serious injury. Save all warnings and instructions for future reference.

- Always ensure anyone intending to operate this machine is fully conversant with the contents of this instruction manual prior to assembling, maintaining or operating the machine.
- Perform assembly operations exactly as described in this manual. Failure to observe this warning may lead to serious injury, death, or damage to the machine.
- Always take care when removing the packaging, to prevent damage to you or to the machine.

IMPORTANT! Before assembling the machine, check all the parts indicated in the manual are in the box. Inspect all the parts for signs of damage. Do not assemble the machine if you observe any damaged components.

NOTE! This machine complies with the Noise Emission Directive 2000/14/EC.

General safety

- Keep this operating and maintenance manual in a safe place for reference at a later date.
- Read the instructions carefully. Be familiar with the controls and the proper use of the cutter.
- Never allow children or people unfamiliar with the instructions to use the machine. Local regulations can restrict the age of the operator.

- Never trim while people, especially children or pets, are nearby. Keep in mind that the operator or user is responsible for accidents or hazards occurring to other people or their property.
- This cutter is not intended for use by people (including children) with reduced physical, sensory or mental capabilities, or lack of experience and knowledge, unless they have been given supervision or instruction concerning the use of the cutter by a person responsible for their safety.
- Do not touch the rotating spool.

Personal safety

- Do not allow children or untrained individuals to use this cutter.
- Never start or run the engine in an enclosed or poorly-ventilated area; breathing exhaust fumes can kill.
- Clear the work area before each use.
Remove all objects, such as rocks, broken glass, nails, wire, or other such debris, which can be thrown or become entangled in the cutting line.
- Wear safety glasses or goggles when operating this machine.
- Wear suitable, long trousers, boots, and gloves. Do not wear loose fitting clothing, shorts, or go barefoot. Do not wear jewellery of any kind.

Operation safety

- Never operate this unit on the operator's left side.
- Long hair below shoulder level should be secured, to prevent entanglement in moving parts.
- Keep all bystanders, children and pets at least 15m (50ft.) away.
- Do not operate the cutter when you are tired, ill, or under the influence of alcohol, drugs, or medication.
- Do not operate the cutter in poor lighting.

- Keep firm footing. Do not overreach.
Overreaching can result in loss of balance or exposure to hot surfaces.
- Keep your body away from any moving parts.
- To avoid hot surfaces, never operate the unit with the bottom of the engine above waist level.
- Do not touch the area around the exhaust or cylinder of the unit; these parts get hot during operation.
- Always stop the engine and remove the spark plug wire before making any adjustments or repairs, except for carburettor adjustments.
- Inspect the unit for loose fasteners, fuel leaks, etc., before each use. Replace any parts found to be worn or damaged.
- The string head will rotate during carburettor adjustments and engine starting.
- It has been reported that vibrations from hand-held tools may, in certain individuals, contribute to a condition called Raynaud's Syndrome. Symptoms may include: tingling, numbness and blanching of the fingers, usually apparent upon exposure to cold. Hereditary factors, exposure to cold and dampness, diet, smoking and work practices are all thought to contribute to the development of these symptoms. It is presently unknown what, if any, vibrations or extent of exposure may contribute to the condition. Measures can be taken by the operator to possibly reduce the effects of vibration:
 - a. Keep your body warm in cold weather. When operating the unit, wear gloves to keep the hands and wrists warm.
It is reported that cold weather is a major factor contributing to Raynaud's Syndrome.
 - b. After each period of operation, exercise to increase blood circulation.

c. Take frequent work breaks. Limit the amount of exposure per day.

d. Keep the cutter well maintained, fasteners tightened and worn parts replaced.

- If you experience any of the symptoms of this condition, immediately discontinue use and see your doctor.
- Mix and store fuel in a container approved for petrol clearly identified as 2-stroke.
- Mix fuel outdoors where there are no sparks or flames. Wipe up any fuel spillage. Move 10m (30ft.) away from the refuelling site before starting the engine.
- Stop the engine and allow it to cool before refuelling or storing the unit.
- Before transporting in a vehicle, allow the engine to cool, empty the fuel tank and secure the cutter from moving.
- Replace the string head if cracked, chipped, or damaged in any way. Be sure the string head is properly installed and securely fastened. Failure to do so can cause serious injury.
- Make sure all guards, straps, and handles are properly and securely attached.
- Use only the manufacturer's replacement string in the cutting head. Do not use any other cutting attachment. To install any other brand of cutting head to this string cutter may result in serious personal injury.
- Never operate the unit without the grass guard in place and in good condition.
- Maintain a firm grip on both handles while trimming. Keep the string head below waist level. Never cut with the string head located over 76cm (30in.) above the ground.

Using brush cutter attachment safely



WARNING! Danger of injury! The machine must not be used to cut hedges, hard branches and wood, or to crush material for compost. Do not use it to cut grass that is not on the ground, e.g. grass growing on walls, rocks, etc.



WARNING! Danger of injury! Rotating blades may lead to serious injuries by cutting or amputating parts of the body.

- Always have your arms and legs a safe distance from the cutting mechanism, in particular after turning the engine on.
- Never touch under the housing body when the engine is running. Safety gloves must be used!
- Never use the brush cutter without the protective cover.
- After the cutter is turned off, the cutting head keeps rotating for a couple of seconds. Keep your arms and legs at a safe distance.
- Always carry the machine by its handle, keeping a safe distance from the blade to avoid the risk of injury.



WARNING! Sharp blades! Take extra care to avoid injury by the rotating blades.

- Never cross any gravel roads or paths whilst the machine is running.

Maintenance



WARNING! Switch off the engine before carrying out any work. Wait until all rotating parts have stopped and the cutter has cooled down.

1. Repairs and works specified in these Instructions may only be performed by qualified authorised staff. Use only original accessories and spare parts.
2. Keep the cutter clean at all times, in particular the air vents. Never spray water on the cutter body! Never clean the cutter and its components with solvents, or flammable or toxic liquids. Use only a damp cloth.
3. Check the cutting equipment function.
4. Only a regularly maintained and well treated cutter can serve as a satisfactory aid. Insufficient maintenance and care can lead to unforeseen accidents and injuries.

PRODUCT DESCRIPTION AND IDENTIFICATIONS

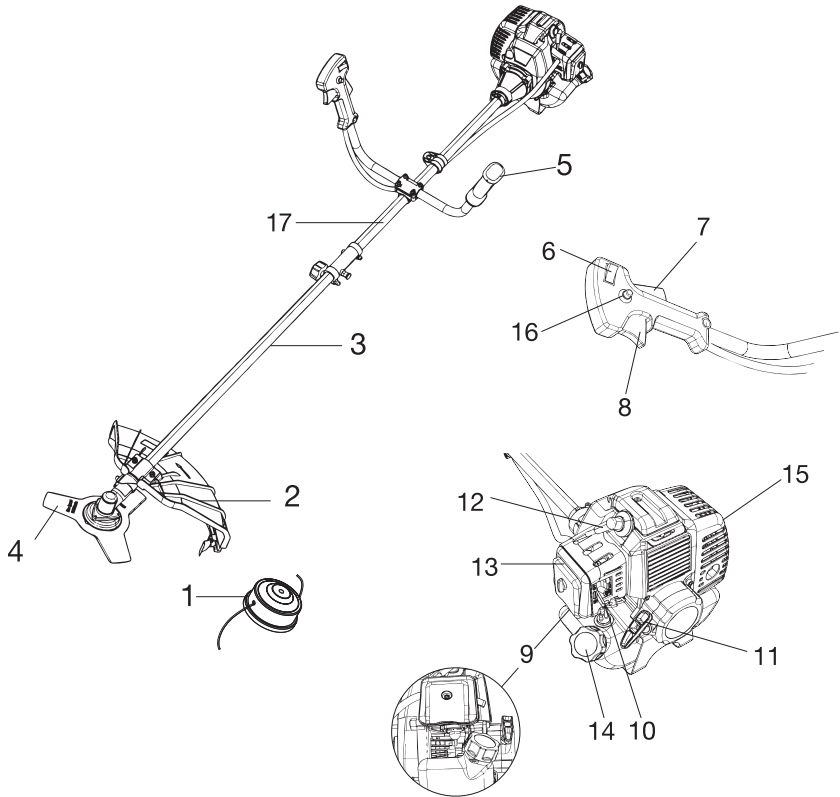

1. Bump feed line spool
2. Safety guard
3. Lower shaft
4. Cutting blade
5. Bike handle
6. Switch On/Off
7. Throttle lock
8. Throttle lever
9. Fuel pump primer bulb

10. Choke lever
11. Recoil starter handle
12. Spark plug boot
13. Air filter housing cover
14. Petrol tank
15. Housing for engine cooler strap
16. Throttle lock
17. Upper shaft

Not all the accessories illustrated or described are included in standard delivery.

ASSEMBLY AND OPERATING INSTRUCTIONS



WARNING!

Take care when removing the packaging to prevent damage to the machine.

Make sure that you have sufficient space to put the machine down. Keep your feet apart so that you have a stable position; bend at the knees and keep your back straight.

Always recycle the packaging in accordance with local recycling schemes.

When assembling this machine, please follow these instructions.

Assemble the bike handle on the machine

1. Assemble the bike handle

Assemble the bike type handle on the machine:

a) Using the 4 mm hex key, loosen the four screws on the handle bar clamp.

b) Place the middle of the bike handle bar on the handle bar clamp.

c) Gently tighten the clamp screws. Adjust the position of the handles to be comfortable for operation. Firmly tighten all the handlebar clamp screws.

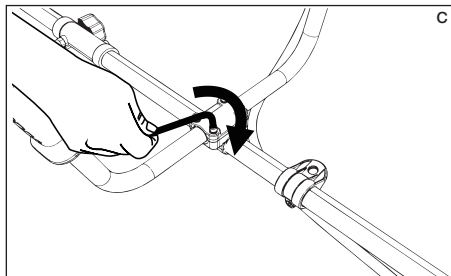
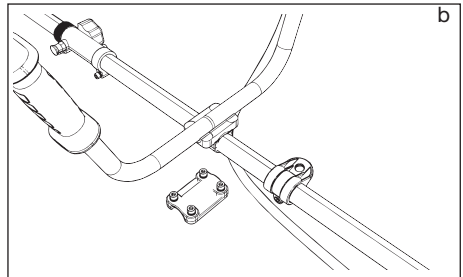
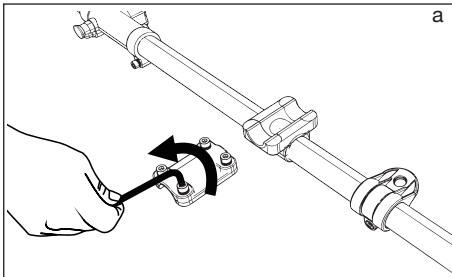

2. Remove the sleeve on the lower shaft

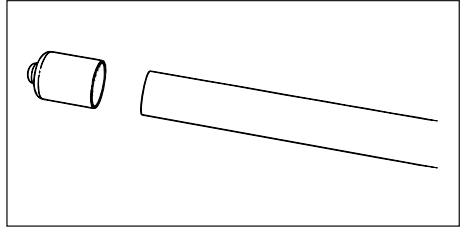
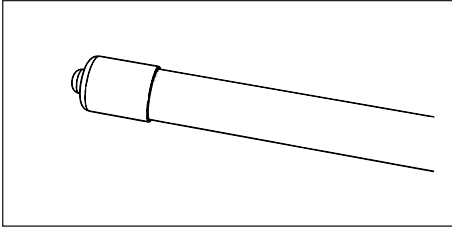

3. Join the upper and lower shafts

Pull the stop pin and slightly rotate it to stop on the depth limit step.

Insert the lower shaft into the clamp. Pull the stop pin and slightly rotate it to be off the depth limit step. Rotate the lower shaft until the stop pin clicks into the hole in the inserted lower shaft.

Make sure that the lower shaft is securely fixed .

Firmly tighten the knob on the clamp.

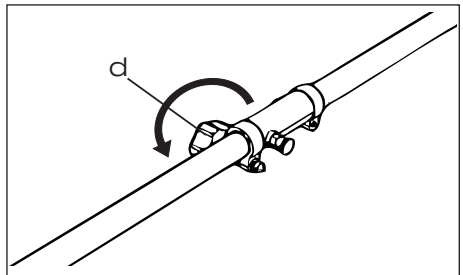
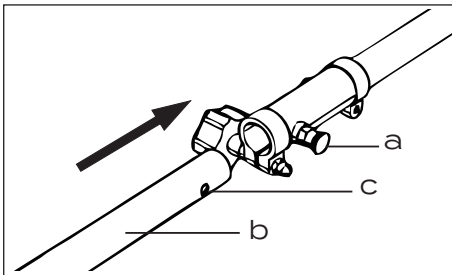

Assemble the safety guard

Remove the two screws from the top of the guard with the hex key.

Hold the Guard underneath the bracket, insert the two screws through the bracket in to the holes in the guard and re-tighten firmly. See picture below.

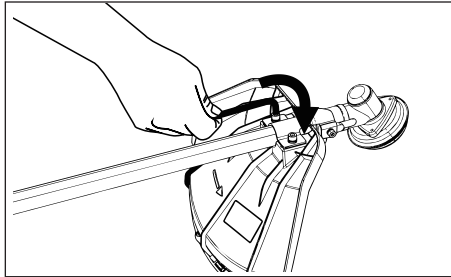
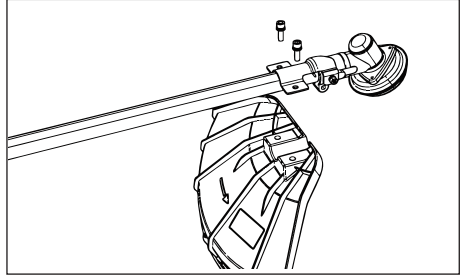
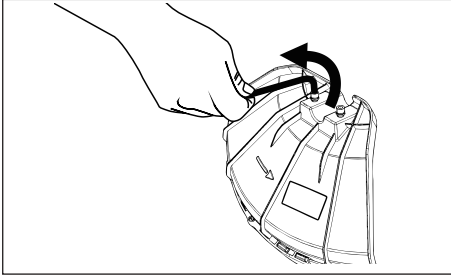

WARNING! Use only original manufacturer's replacement parts, accessories and attachments. Failure to do so can cause poor performance, possible injury and may void your warranty. Never use the machine without the guard assembled!

Assemble the line spool or cutting blade

Line up the two holes of the flange and shield (black one). Lock the spindle by inserting the 5mm hex key through the holes as shown in the picture below. Turn the socket wrench clockwise until the nut is released. Take out inner flange(a), outer flange(b), protect cover plate(c), nut(d).

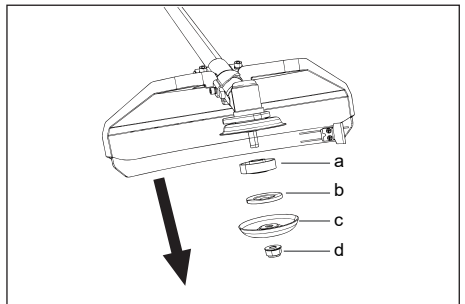
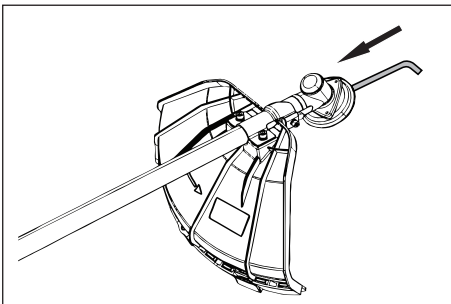

A. Assemble the line spool

Line up the two holes of the flange and shield(black one). Lock the spindle by inserting the 5mm hex key through the holes. Mount the inner flange(a) and line pool into the spindle and rotate counter-clockwise until the line spool is fitted securely.

Remove the hex key to unlock the spindle.

Store the outer flange(b), protective cover plate(c) and nut(d) in a safe place in case they are needed for later use.

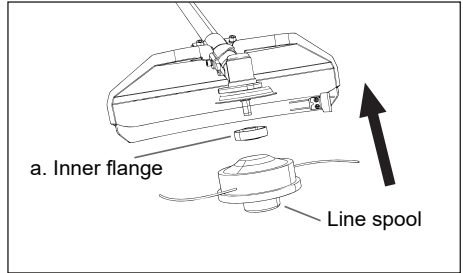
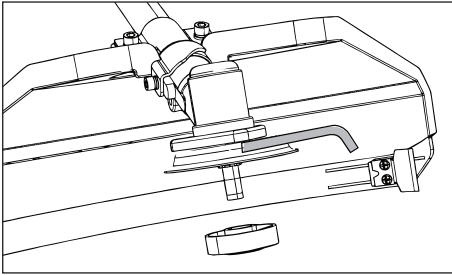

B. Assemble the cutting blade

Line up the two holes of the flange and shield(black one). Lock the spindle by inserting the 5mm hex key through the holes. Mount the inner flange(a), blade, outer flange(b), protect cover plate(c), nut(d) into the spindle according to priority and rotate counter-clockwise until the cutting blade is fitted securely. See the pictures below.

NOTE: The blade rotation direction needs be the same as the picture below. Surface with printed specification on blade need to be on the upside. Use the screwdriver to hold the spindle and tighten the nut counter-clockwise. Use wrench to tight the nut and ensure the nut is tightened securely.

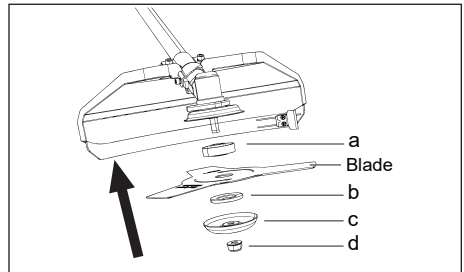
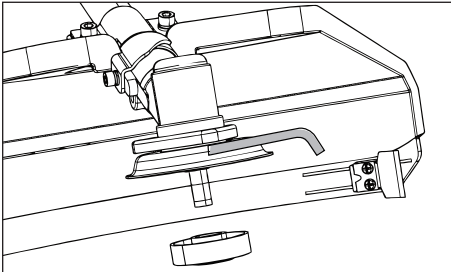

WARNING!

Make sure the cutting blade has been assembled correctly before use!

Fit the strap

The brush cutter must always be used with the double shoulder harness provided.

1. Put the left and right straps over the shoulders and secure with the quick-connect function of the harness. The finished set-up should resemble the picture below.

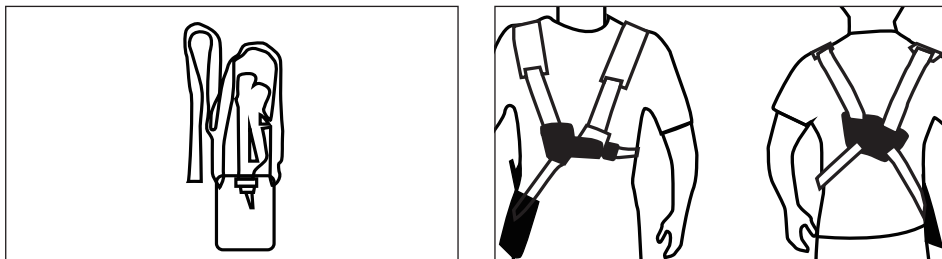

Note: At the front of the harness there is an easily accessible quick-release function. Use the quick release in any emergency situation that requires you to free yourself from the machine and harness.

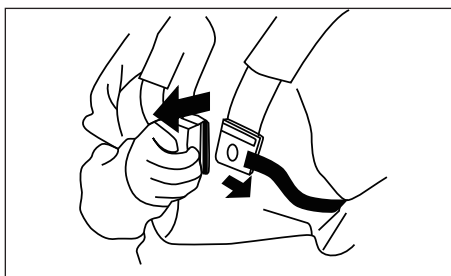

2. Hook the double belt harness into the strap support ring on the shaft tube.

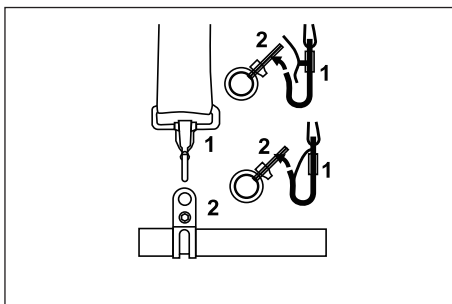
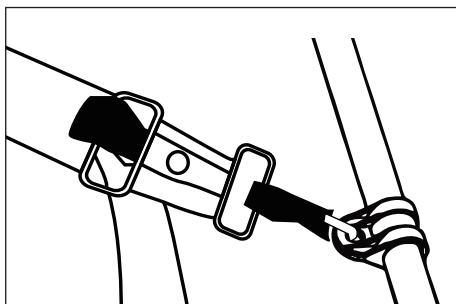
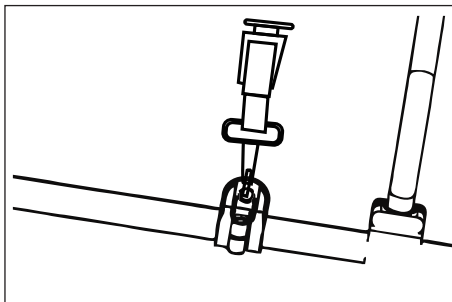
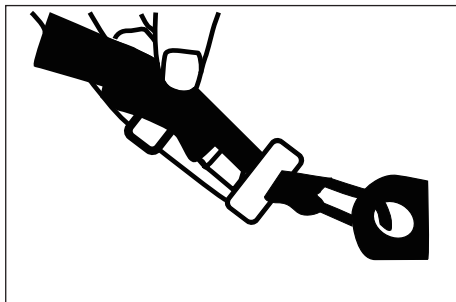

3. Adjust the length of the harness so that the hook is approximately 15 cm below your waist.

In case of emergency, pull the rope of the quick release mechanism. The metal locking bar will be released automatically because of the weight of the machine, and the machine will drop away from you.

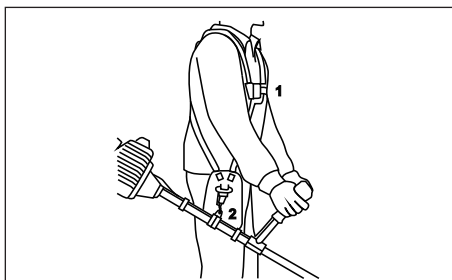

NOTE: Let the cutting attachment rest lightly on the ground. When using the brush cutter blade, it should balance about 10cm above the ground to prevent contact with stones and the like. Adjust the position of the harness clamp to balance the unit correctly.

PREPARATION

Fuel and oil mixture



WARNING! Always switch the engine off before fuelling.

Never add fuel to a machine with a running or hot engine. Move at least 30ft. (9m) from the refuelling site before starting the engine. Do not smoke!



IMPORTANT! Keep the bottle level and stable while filling and use a suitable funnel (not supplied).

This product is powered by a 2-stroke engine and requires premixing of petrol and 2-stroke oil. Mix a high quality 2-stroke engine oil. Do not use automotive oil or 2-stroke outboard oil. DO NOT mix too much volume which cannot be used in a 30-day period.

Danger of injury! Fuel is explosive!

Turn off and cool the engine down before filling the tank with fuel. You must observe all safety instructions relating to handling fuel.

Risk of damage!

The machine does not come supplied with 2 stroke engine oil.

1a. Fuel mixture

1 litre (1000ml) petrol: 25cc (25ml) 2-stroke engine oil (40:1 ratio). Using a funnel and keeping the bottle level, pour the fuel to the side marked petrol, and pour engine oil to the side marked oil.

Mount and tighten the caps securely. Shake vigorously to mix the two products prior to pouring into the tank of the brush cutter.

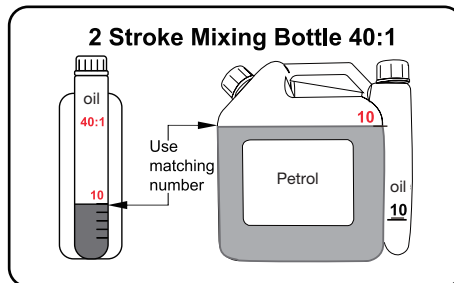

1b. Filling tank

Clean the surface around the fuel cap to prevent contamination.

Loosen the fuel cap slowly, remove and rest the cap on a clean surface. Carefully pour fuel into the tank, avoiding spillage. Prior to remounting the fuel cap, clean and inspect the seal located inside the fuel cap. Immediately remount the fuel cap and tighten securely. Wipe up any fuel spillage.

NOTE: It is normal for smoke to be emitted from a new engine during and after the first use.

OPERATION

When working with the machine, the appropriate safety guard must be fitted to prevent objects being thrown out.

The integrated blade fixed on the safety guard automatically cuts the line to the optimum length.



ATTENTION! Before operating, you must fill the machine with fuel.

Starting the unit

Do not start the brush cutter until it has been completely assembled.

Danger of injury!

Do not operate the device unless you did not find any faults. If a part has become defective, be sure to replace it before you use the device again.

Check before use!

Check the safe condition of the machine.

Check the machine for leaks.

Check the machine for visual defects.

Check that all parts of the machine have been securely fitted.

Check that all safety devices are in proper condition.

Danger of injury!

Before starting work, always check the ground and remove all objects that could be thrown by the machine.

Start

Once the machine has been set up properly, start the engine as follows:

1. Set the machine down on a hard, level surface.
2. Turn the engine switch (6) to the 'I' position.

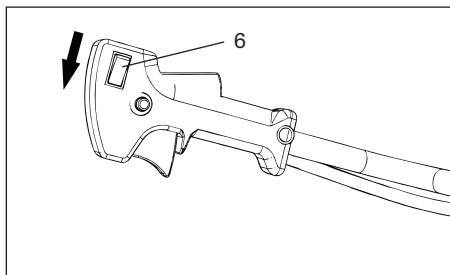

3. Put the choke lever (10) in  position.

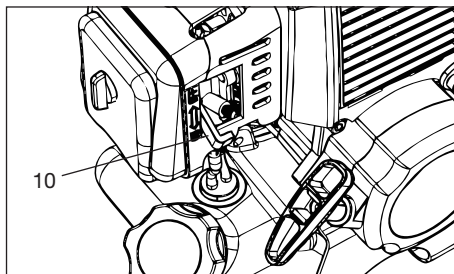
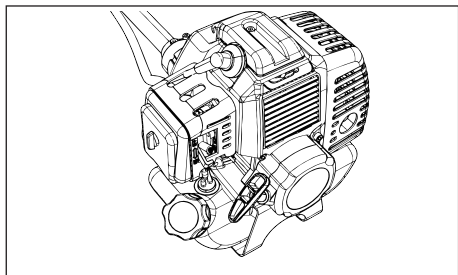

4. Press the primer bulb 5 times.

Note: If the engine is warm, move the choke lever (10) to the  position, do not press the primer bulb.

5. Press and hold the machine then pull the recoil starter handle 5-6 times to start the engine.

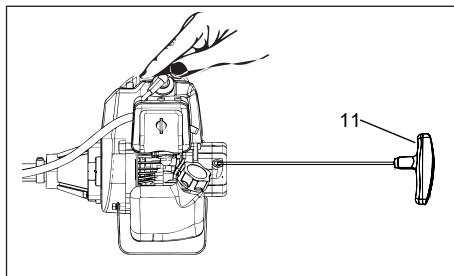
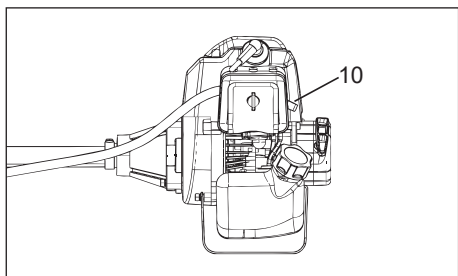

6. Once the engine is running smoothly (approx 5-10 seconds) adjust the choke lever  position to slowly. Engine may stop if the choke lever is adjusted rapidly.

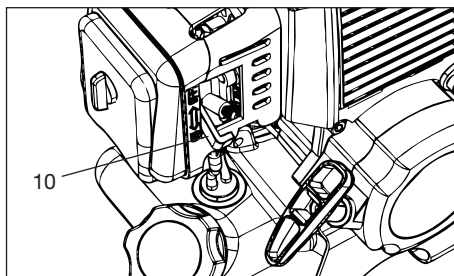
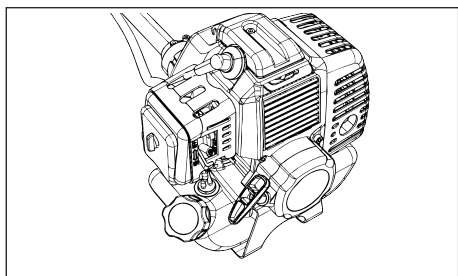

7. Run the machine for 30 seconds at idle speed, press the throttle lock (7), then hold throttle lever (8) to increase the speed. When the throttle lever(8) is depressed approximately 50% the throttle lock (16) can be pressed if required. This will hold the throttle at this point. To disengage the cold start switch squeeze the throttle lever fully and release.

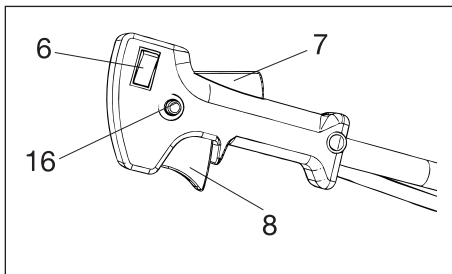

WARNING! If the brush cutter vibrates excessively. STOP the engine immediately and investigate the cause.

8. Adjusting line length while working:

This machine is fitted with a Bump to Feed Line. To release more line, tap the cutting line head against the ground with the engine at top speed; the line will be released automatically and the blade fixed on the safety guard will cut off the excess length.

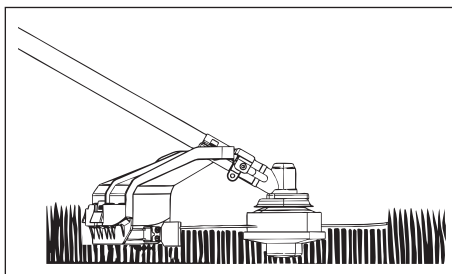

9. If you encounter any problems, turn the engine switch to the 'O' position to turn off the engine and the machine will stop.

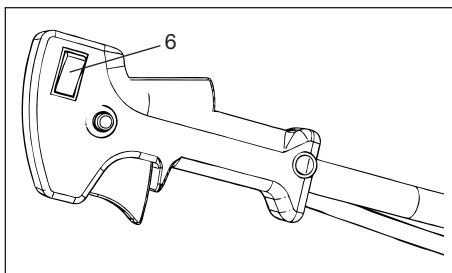

10. If any problem occurs, pull the rope of the quick release mechanism. The metal locking bar will be released automatically because of the weight of the machine, and the machine will drop away from you.

11. If the engine is hot, on/off switch level can be adjusted to the 'I' position when restarting the brush cutter.

NOTE: If the engine does not start up after several attempts, read the section '**Troubleshooting**'.

NOTE: Friction around the eyelet will be created and the chord will become frayed if pulled at an angle. This may result in premature breakage of the chord. The recoil starter handle should be allowed to slowly return back to its starting position and never be allowed to 'snap back'.

NOTE: Do not start the motor in long grass.

ATTENTION: When the engine has been switched off, the cutter continues running for several seconds; therefore, do not touch the cutter head until it has come to a complete standstill.

Working instructions

Extending the cutting line



CAUTION! Do not use any kind of metal wire or metal wire encased in plastic in the line spool. This may cause serious injuries to the user. To extend the cutting line, run the engine at full speed and tap the line spool on the ground.

This will automatically extend the line.

The blade on the safety guard will cut the line to the appropriate length.

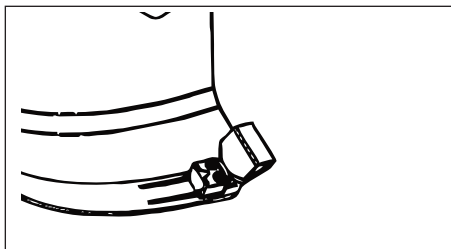

IMPORTANT: Remove all grass and weed remnants at regular intervals to prevent the shaft tube overheating. Lawn, grass and weed remnants become trapped under the safety guard, preventing the shaft tube from receiving adequate ventilation. Remove the remnants carefully using a suitable tool. Do not use bare hands.

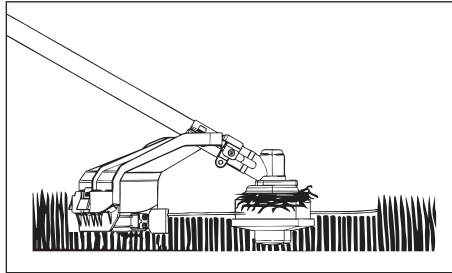

Different cutting methods

When the machine is correctly assembled it will cut weeds and long grass in places that are difficult to access, e.g. along fences, walls, foundations, and trees. It can also be used for 'mowing' down vegetation to prepare a garden for other applications.

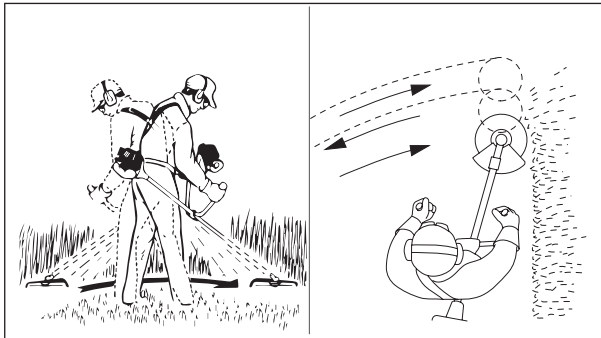

ATTENTION: Even if it is used carefully, cutting around foundations, stone or concrete walls will result in the line suffering more than normal wear.

Trimming/mowing

Swing the trimmer from side to side in a scything motion. Always keep the line spool parallel to the ground. Check the site and decide which cutting height you require. Guide and hold the line spool at the required height to obtain an even cut.

Low trimming

Hold the trimmer right in front of you at a slight angle so that the underside of the line spool is above the ground and the line is at the required height. Always cut away from yourself and never draw the machine towards you.

Cutting along fences/foundations

Approach wire mesh fences, lath fences, natural stone walls and foundations slowly so that you can cut close to them without striking the obstacle with the line. If, for example, the line strikes stones, stone walls or foundations, it will wear or fray. If the line strikes wire fencing, it will break.

Trimming around trees

When trimming around tree trunks, approach slowly so that the line does not strike the bark. Walk around the tree, cutting from left to right. Approach grass or weeds with the tip of the line and tilt the line spool forwards slightly.



WARNING! Take extreme care during mowing work. When doing such work, keep a distance of 30 metres between yourself and other people or animals.

Mowing

When mowing, you want to cut all the vegetation down to the ground. To do this, set the line spool at an angle of 30° to the right.

Place the handle in the required position.

Remember the increased risk of injury to the user, bystanders and animals, and the danger of damaging property due to objects (for example stones) being thrown.



WARNING! Do not use the machine to remove objects from footpaths, etc. The machine is a powerful tool and can throw small stones and other objects a distance of 15 metres or more, causing injuries and damage to cars, houses and windows.

Jamming

If the cutting blade jams as a result of attempting to cut vegetation that is too dense, switch off the engine immediately. Remove the grass and scrub from the machine before restarting.

Preventing recoil

When working with the blade, there is a risk of recoil if it strikes solid objects, such as tree trunks, branches, tree stumps or stones. This will throw the cutter backwards in the direction opposite to the rotation of the tool. This can cause you to lose control of the cutter. Do not use the blade near fences, metal posts, boundary stones or foundations.

CARE AND CLEANING



INJURY WARNING: Always wear protective gloves when working on or around cutting equipment.

BEFORE EACH USE

- Remove dirt and debris from the tool exterior.
- Check all screws for tightness and tighten if necessary.
- Check blade flange nut is tight and tighten if necessary.
- Check the blade for damage. Replace if damaged or cracked.
- Inspect the engine, tank and hoses for possible fuel leaks, and repair as necessary.
- Inspect the engine cooling fins for accumulations of dirt or debris, and clean as necessary.

EVERY 12 HOURS OF USE

- Loosen and remove the air filter cover and filter element.
- Inspect the element. If the filter element is distorted or damaged, replace it with a new one.
- Wash the filter element in clean fuel, and squeeze or blow dry.
- Reinstall the filter element and air filter cover to the tool.
- Use the spark plug wrench to remove the spark plug (turn anticlockwise to remove).
- Clean and adjust the spark plug gap to 0.5-0.7 mm. Replace any damaged or visibly worn plug with a L8RTF spark plug or equivalent.
- Reinstall the spark plug by hand, then tighten it firmly with the spark plug wrench.

EVERY 24 HOURS OF USE

- Loosen and remove the air filter cover and filter element.
- Inspect the element. If the filter element is distorted or damaged, replace it with a new one.
- Wash the filter element in clean fuel, and squeeze or blow dry.
- Reinstall the filter element and air filter cover to the tool.
- Use the spark plug wrench to remove the spark plug (turn anticlockwise to remove).
- Clean and adjust the spark plug gap to 0.5-0.7 mm. Replace any damaged or visibly worn plug with a L8RTF spark plug or equivalent.
- Reinstall the spark plug by hand, then tighten it firmly with the spark plug wrench.

EVERY 36 HOURS OF USE

- **CLEANING** - Thoroughly clean the tool exterior.
- **INSPECTION** - Inspect the entire tool for damage, including loose or missing components and repair as necessary.
- **FUEL** - Drain the fuel tank and then clear the carburetor and lines by running the tool until it stops from lack of fuel.
- **LUBRICATION** - Remove the spark plug and then pour approximately a teaspoon of 2 stroke oil into the cylinder through the spark plug hole. Before reinstalling the spark plug, pull the starter 2 or 3 times to distribute the oil over the cylinder walls.

- AIR FILTER - Replace.
- Use the spark plug wrench to remove the spark plug (turn anticlockwise to remove).
- Spark plug – Replace

STORAGE (30 DAYS OR LONGER)

- CLEANING - Thoroughly clean the tool exterior.
- INSPECTION - Inspect the entire tool for damage, including loose or missing components and repair as necessary.
- FUEL - Drain the fuel tank and then clear the carburetor and lines by running the tool until it stops from lack of fuel.
- LUBRICATION - Remove the spark plug and then pour approximately a teaspoon of 2 stroke oil into the cylinder through the spark plug hole. Before reinstalling the spark plug, pull the starter 2 or 3 times to distribute the oil over the cylinder walls.
- AIR FILTER - Remove, clean and reinstall the filter element.
- STORAGE - Store the tool in a clean, dry, dust-free environment.

If necessary:

Retighten accessible fastening screws and nuts. You will avoid excessive wear and tear and damage to the machine when you follow the instructions in this manual.

Replacing the line spool/cutting line

1. Dismantle the line spool as described in the 'Assembly' section.

Press the spool together and remove one half of the housing.

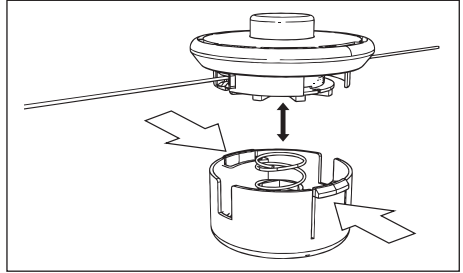
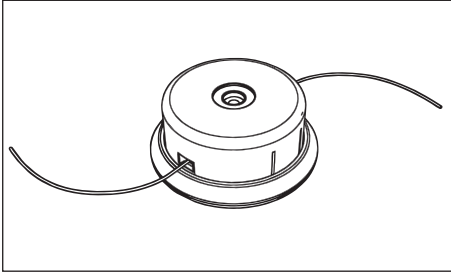

2. Take the spool plate out of the line spool housing.

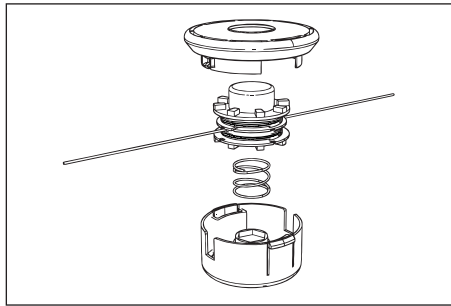

3. Remove any remaining cutting line.

4. Place the new cutting line in the centre and hang the loop which has formed into the recess in the spool splitter.

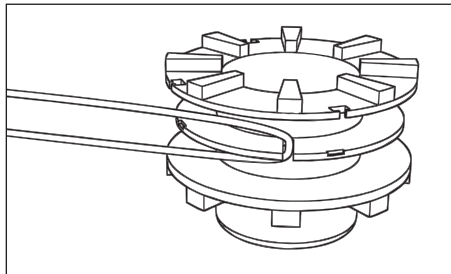

5. Under tension, wind the line onto the spool counter clockwise.

The spool splitter will separate the two halves of the line.

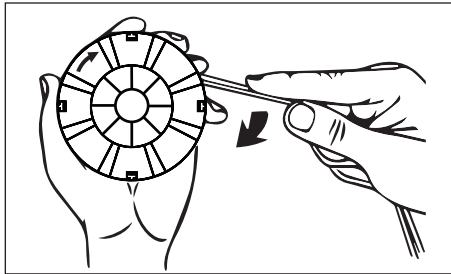

6. Hook the last 15cm of the two ends of the line onto the opposite lying line holders of the spool plate.

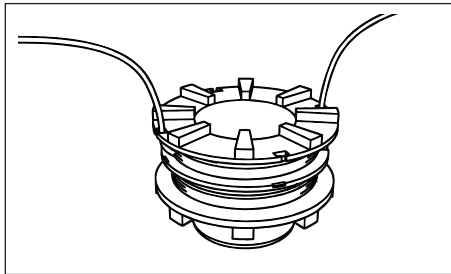

7. Thread the two ends of the line through the metal eyelets in the line spool housing.

8. Press the spool plate into the line spool housing.

9. Pull the two line ends sharply to release them from the line holders.

10. Join the housing parts together again.

11. Cut the excess line to a length of around 13cm. This will reduce the load on the engine when starting and warming up.

12. Remount the line spool. If you are replacing the complete line spool, skip '**Assembly**'.

Sharpening the cutting blade

The cutting blade can become blunt over time. When you notice this, undo the screw holding the cutting blade on the safety guard.

Clamp the blade in a vice.

Sharpen the blade with a flat file and make sure that the angle of the cutting edge is not altered in the process. File in one direction only.

An unbalanced blade will cause the brush cutter to vibrate violently and may result in an accident or injury to the operator.

Change and clean the spark plug

1. Once the engine has cooled, remove the spark plug using the socket spanner supplied.

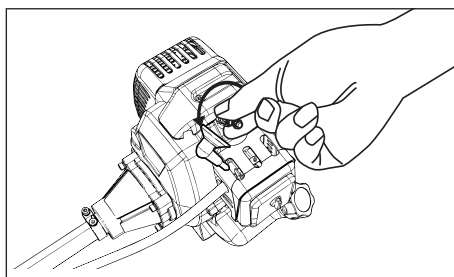
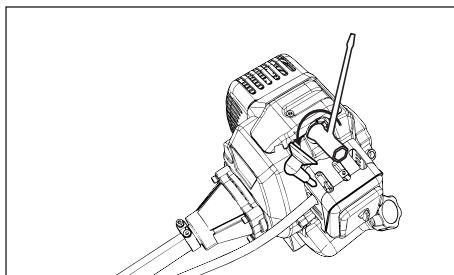
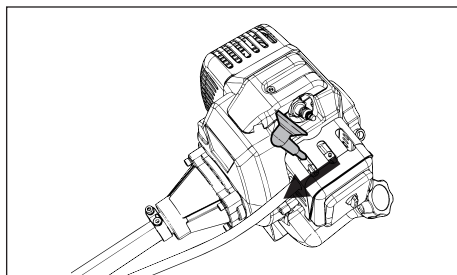

2. Clean the plug with a wire brush.

3. Using a feeler gauge, set the gap to 0.5-0.7mm.

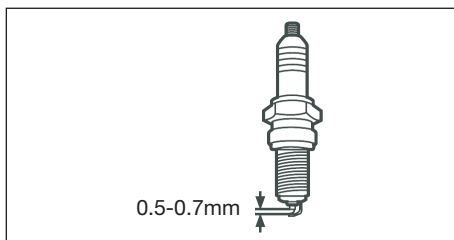

4. Install the spark plug carefully by hand to avoid cross-threading.

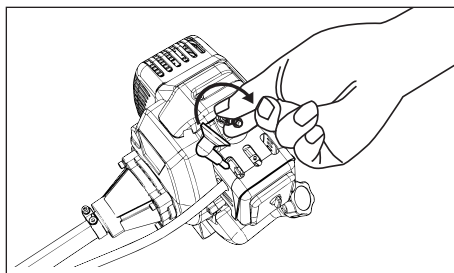

5. After the spark plug is seated, tighten with a spanner to compress the washer.

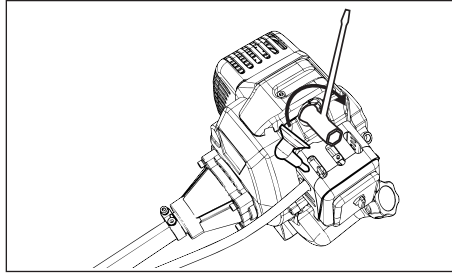

Change and clean the air filter

Soiled air filters reduce the engine power by supplying too little air to the carburettor. Regular checks are therefore essential.

1. Unclip the air filter cover and remove the sponge filter element.
2. To avoid objects falling into the air tank, remount the air filter cover.
3. Wash the filter element in warm soapy water, rinse and allow to dry naturally.

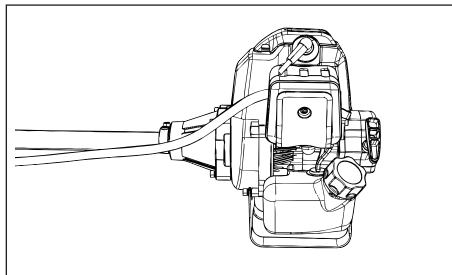
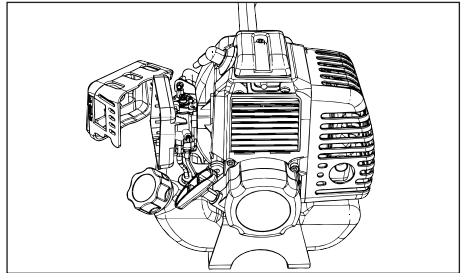
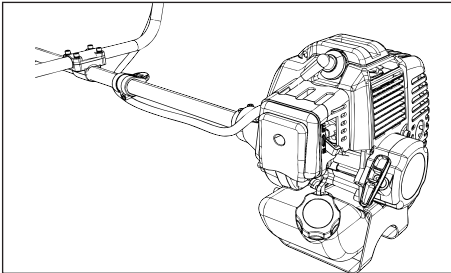

IMPORTANT: Never clean the air filter with petrol or flammable solvents.
WARNING! Never run the engine without the air filter element installed.

Transport

Due to safety reasons, please see to it that the cutter is transported free of oil and petrol!

Worn parts

Even when used in the intended way, some components are subject to normal wear. They will have to be replaced depending on the duration of usage. These parts include, among others, the cutting tool and the retaining disk.



WARNING! Use only the original manufacturer's replacement parts, accessories and attachments. Failure to do so can cause poor performance, possible injury and may invalidate your warranty.

Replacement parts/accessories:

Machine/brush cutter:

Spool with Ø 480	ATCD021023
Blade with 3 teeth Ø 255 x 1.4	ATCD021024
Safety guard for machine	ATCD021030

Storing the cutter

If you intend to store the cutter for longer than 30 days, it must be prepared accordingly; otherwise, the fuel still remaining in the carburettor will evaporate and leave a rubbery sediment. This can cause problems when starting up the machine and may require expensive repairs.

Slowly remove the fuel tank cap to release any pressure that may have in the tank. Carefully empty the tank.

To remove the fuel from the carburettor, start the engine and let it run until the cutter stops.

Leave the engine to cool (approx. 5 minutes).

Remove the spark plug (see section **Change and clean the spark plug**).

Add one teaspoon of 2-stroke engine oil into the combustion chamber. Slowly pull the starter cord several times to apply a layer of oil to all internal components. Fit the spark plug again.

NOTE: Store the cutter in a dry place and far away from possible ignition sources.

Putting the cutter back into operation

Remove the spark plug (see section **Change and clean the spark plug**).

Quickly tug on the starter cord to remove excess oil from the combustion chamber.

Clean the spark plug and check that the electrode gap is correct, or insert a new spark plug with the correct electrode gap.

Prepare the equipment for operation.

Fill the tank with the relevant mixture of fuel and oil (see the section **Fuel and oil mixture**).

TROUBLE SHOOTING

The table below contains a list of fault symptoms and explains what you can do to remedy the problem if your cutter fails to work properly. If the problem persists after working through the list, please contact your nearest service workshop.

PROBLEMS	POSSIBLE CAUSES	REMEDIES
The cutter does not start	<ol style="list-style-type: none"> 1. Correct starting procedure not followed 2. Sooted or damp spark plug 3. Incorrect carburettor setting 4. Blade or Nylon cutter mounted incorrectly 5. No fuel in the tank 	<ol style="list-style-type: none"> 1. Follow the instructions for starting 2. Clean the spark plug or replace it with a new one 3. Contact an authorised customer service outlet 4. Reassemble the blade or Nylon cutter 5. Check the fuel level
The cutter starts but does not develop its full power	<ol style="list-style-type: none"> 1. Incorrect choke lever setting 2. Soiled air filter 3. Incorrect carburettor setting 4. Blunt cutting blade 	<ol style="list-style-type: none"> 1. Set the choke lever on the position 2. Clean the air filter 3. Contact an authorised customer service outlet 4. Have cutting blade re-sharpened/ replaced
The engine does not run smoothly	<ol style="list-style-type: none"> 1. Incorrect electrode gap on the spark plug 2. Incorrect carburettor setting 	<ol style="list-style-type: none"> 1. Clean the spark plug and adjust the electrode gap, or fit a new spark plug 2. Contact an authorised customer service outlet
Engine smokes excessively	<ol style="list-style-type: none"> 1. Incorrect fuel mix 2. Incorrect carburettor setting 	<ol style="list-style-type: none"> 1. Use the correct fuel mix (see fuel mixing table) 2. Contact an authorised customer service outlet
If the temperature of machine is too high	Engine is overloaded	Ensure the machine has a rest period

NOTE: IF YOU EXPERIENCE A PROBLEM WITH YOUR PRODUCT, PLEASE DO NOT ATTEMPT TO OPEN OR REPAIR THE PRODUCT YOURSELF. DOING SO MAY VOID THE WARRANTY AND COULD CAUSE DAMAGE OR PERSONAL INJURY. IF THE PROBLEM STILL PERSISTS, PLEASE CONTACT US BY REFERRING TO THE SERVICE & SUPPORT INFORMATION ON THE FOLLOWING PAGE.

DECLARATION OF CONFORMITY / PERFORMANCE



Product Code: 66933 (BC520)

Product Description Hawksmoor: 52cc Brush cutter

1. Toolstation Limited, Express Park, Bristol Road, Bridgwater, Somerset TA6 4RN

This declaration of conformity is issued under the sole responsibility of Toolstation

2. Object of the declaration

The object of the declaration described above is in conformity with the relevant Community harmonization legislation:

Supply of Machinery (Safety) Regulations 2008

2006/42/EC

Electromagnetic Compatibility Regulations 2016

2014/30/EU

Noise Emission in the Environment by Equipment for use Outdoors Regulations 2001

2000/14/EC amended by 2005/88/EC:

-Conformity Assessment Procedure as per Annex VI

-Measured Sound Power Level 97 dB(A)

-Declared Guaranteed Sound Power Level 114 dB(A)

3. References to the relevant standards used (or references to the specifications in relation to which conformity is declared:

BS EN ISO 11806-1 BS EN ISO14982

4. Additional information:

Signed for and on behalf of Toolstation Limited

ENVIRONMENTAL INFORMATION

Old products are potentially recyclable and do not, therefore, belong in your household rubbish. You are requested to assist us and our contribution to saving resources and protecting the environment by handing in this product at an equipped collection centre (if there is one available).

Petrol, oil, used oil, a mixture of oil and petrol and objects soiled with oil e. g. cleaning cloths do not belong in the household rubbish. Dispose of oil-contaminated items in accordance with the local guidelines and hand them in at recycling centres.

The product comes in a package that protects it against damage during shipping. Keep the package until you are sure that all parts have been delivered and the product is function properly. Recycle the package afterwards.

GUARANTEE

Toolstation products deliver reliable service for normal, household use in domestic settings. All Toolstation products are individually tested before leaving the factory.

If you are a consumer and you experience a problem with your Toolstation product, which is found to be defective due to faulty materials or workmanship within the Guarantee Period, this Toolstation Guarantee will cover repair or - at the discretion of Toolstation – replacement with a functionally equivalent Toolstation product.

Your product is under guarantee for 2 year from the date of purchase or the date of delivery of the product, if later.

The guarantee is subject to the following provisions:

- The guarantee does not cover accidental damage, misuse, cabinet parts, knobs, or consumable items.
- The product must be correctly installed and operated in accordance with the instructions contained in this manual.
- It must be used solely for domestic purpose.
- The guarantee will be rendered invalid if the product is re-sold or has been damaged by inexpert repair.
- Specifications are subject to change without notice.
- The manufacturer disclaims any liability for the incidental or consequential damages.
- The guarantee is in addition to, and does not diminish your statutory or legal rights.

CUSTOMER SUPPORT

www.coreservice.co.uk

Call us +44 01904 947568

Email: support@coreservice.co.uk

Made in China