

Original User's Instructions

127.1cc Self Propelled Petrol Lawnmower

SKU: 81854

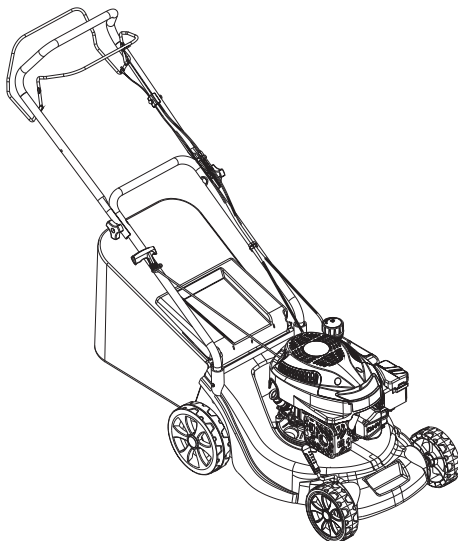

WHAT'S IN THE BOX



Lawn mower x 1



Lower handle x 1



Collection box x 1



Knob x 2



Cable clamp
x 1



Square neck x 2



Spark plug wrench /
socket wrench x 1



Socket wrench
rod x 1



Cross screw driver
x 1

If you do not have all these items, please contact:

www.coreservice.co.uk

Hotline: +44 01904 947568

Email support@coreservice.co.uk

PLEASE KEEP THESE INSTRUCTIONS FOR FURTHER REFERENCE

SPECIFICATION

Technical Data	
Property	Value
Engine type	Single cylinder 4-stroke
Engine displacement	127.1cm ³
Nominal power	2kW
Engine speed	2900/min
Cutting width	40cm
Grass bag capacity	45L
Ignition	T.C.I
Fuel tank capacity	0.8L
Oil tank capacity	0.5L
Sound pressure level	85 dB(A), K _{PA} =3 dB(A)
Sound power level	96 dB(A)
Vibration	6.5m/s ² , K=1.5m/s ²
Spark type	TORCH/F5RTC
Net weight	20.6kg

EXPLANATIONS AND SYMBOLS, CAUTIONS AND WARNINGS



Read the user manual before using the machine.



You must always wear safety goggles to guard your eyes from flying debris, ear plugs or similar ear defenders to protect your hearing and a safety helmet to protect against the risk of falling objects.



Important! Wear gloves to protect your hands.



Wear safety boots to protect your feet.



Warning! Danger!



Sound level data (96 dB) in accordance with Directive 2000/14/EC



Keep bystanders away.



Keep hands and feet away from the blades.



No naked flames.



Hot surfaces will burn fingers or palms.



Warning! The lawnmower exhaust gas contains toxic substances. Do not run the engine in closed or poorly ventilated areas.



Blade continues to rotate for a period after the machine is switched off. Do not touch the blade until all the machine components have been stopped completely.



Do not operate the engine indoors.



Risk of fire/flammable materials.



Stop the engine before refuelling the fuel tank.



Add fuel before operating.



The product complies with the applicable European directives and an evaluation method of conformity for these directives was done.



UK Conformity Assessed

HEALTH AND SAFETY

Important - Please read these instructions fully before starting assembly



The following warning symbols appear throughout this assembly manual and indicate the appropriate safety measures you should take when assembly and operating the lawnmower.

This symbol indicates there is a danger of serious personal injury or death if you do not observe the warning.



This symbol indicates that there is a danger of damaging your hands if you do not wear thick, hard wearing gloves.



WARNING!

- Keep this assembly manual in a safe place following assembly for reference at a later date.
- Always ensure anyone intending to operate this lawnmower is fully conversant with the contents of this assembly manual prior to assembling, maintaining or operating the lawnmower.
- Perform assembly operations as described in this manual. Failure to observe this warning may lead to serious injury, death, or damage to the lawnmower.



- Always take care when removing the packaging to prevent damage to you or to the lawnmower.



IMPORTANT! Before assembling the lawnmower, check all the parts indicated in the manual are in the box. Inspect all the parts for signs of damage. Do not assemble the lawnmower if you observe any damaged components.

NOTE! This lawnmower complies with the Noise Emission Directive 2000/14/EC.



WARNING! Only operate the lawnmower if you are wearing the correct Personal Protective Equipment (PPE) as described in the following warnings.



WARNING! Always wear suitable gloves when operating lawnmower to protect your hands from flying debris and/or sharp objects.

General Safety



WARNING!

- Keep this operating and maintenance manual in a safe place for reference at a later date.
- Read the instructions carefully. Be familiar with the controls and the proper use of the equipment.
- Never allow children or people unfamiliar with these instructions to use the lawnmower. Local regulations can restrict the age of the operator.
- Never mow while people, especially children, or pets are nearby. Keep in mind that the operator or user is responsible for accidents or hazards occurring to other people or their property.
- This appliance is not intended for use by people (including

children) with reduced physical, sensory or mental capabilities, or lack of experience and knowledge, unless they have been given supervision or instruction concerning use of the appliance by a person responsible for their safety.

- Do not touch rotating blade.

Personal Safety



WARNING!

- While mowing, always wear substantial footwear and long trousers. Do not operate the equipment when barefoot or wearing open sandals.
- Thoroughly inspect the area where the equipment is to be used and remove all objects which can be thrown by the machine.
- Petrol is highly ammable: store fuel in containers specifically designed for this purpose.
 - a) refuel outdoors only and do not smoke while refueling.
 - b) add fuel before starting the engine. Never remove the cap of the fuel tank or add petrol while the engine is running or when the engine is hot.
 - c) If petrol is spilled, do not attempt to start the engine but move the machine away from the area of spillage and avoid creating any source of ignition until petrol vapours have dissipated.
 - d) replace all fuel tank and container caps securely.-
Replace faulty silencers.
- Prior to use, visually inspect to see that the blade, blade bolts and cutter assembly are not worn or damaged. Replace worn or damaged blades and bolts in sets to preserve balance.

Operation Safety



WARNING!

- Do not operate the engine in a confined space where dangerous carbon monoxide fumes can collect.
- Mow only in daylight or in good artificial light.
- Avoid operating the equipment on wet grass, where feasible.
- Always be sure of your footing on slopes.
- Walk, never run.
- Mow across the face of slopes, never up and down.
- Exercise extreme caution when changing direction on slopes.
- Do not mow excessively steep slopes.
- Use extreme caution when reversing or pulling the lawnmower towards you.
- Stop the blade if the lawnmower has to be tilted for transportation when crossing surfaces other than grass, and when transporting the lawnmower to and from the area to be mowed.
- Never operate the lawnmower with defective guards, or without safety devices, for example deflectors and/or grass catchers, in place.
- Do not change the engine governor settings or over speed the engine.
- Start the engine carefully according to instructions and with feet well away from the blade.
- Do not tilt the lawnmower when starting the engine.
- Do not start the engine without the grass collector located.
- Do not put hands or feet near or under rotating parts. Keep clear of the discharge opening at all times.
- Never pick up or carry a lawnmower while the engine is running.

- Stop the engine and disconnect the spark plug cable, making sure that all moving parts have come to a complete stop.
 - a) Before clearing blockages or unclogging chute.
 - b) Before checking, cleaning or working on the lawnmower.
 - c) After striking a foreign object, inspect the lawnmower for damage and make repairs before restarting and operating the lawnmower.
 - d) If lawnmower starts to vibrate abnormally, check immediately.
- Stop the engine and disconnect the spark plug wire, make sure that all moving parts have come to a complete stop before refueling.

Maintenance and Storage



WARNING!

- Keep all nuts, bolts and screws tight to be sure the equipment is in safe working condition.
- Never store the equipment with petrol in the tank inside a building where fumes can reach an open flame or spark.
- Allow the engine to cool before storing in any enclosure.
- To reduce the fire hazard, keep the engine, silencer, and petrol storage area free of grass, leaves, or excessive grease.
- Check the grass bag frequently for wear or deterioration.
- Replace worn or damaged parts for safety.
- If the fuel tank has to be drained, this should be done outdoors.

Intended Use

This mower is designed for domestic lawn mowing only. Use in any other way is considered contrary to the intended use. Compliance with the operation, service and repair as specified in this handbook also constitute essential elements of the intended use.

COMPONENT LIST

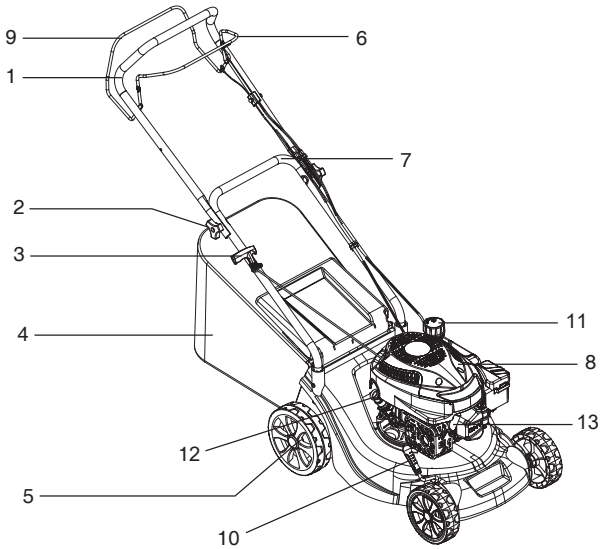

- 1 Upper handle
- 2 Knob
- 3 Starter
- 4 Collection bag
- 5 Wheel
- 6 Start stop lever
- 7 Lower lever
- 8 Engine
- 9 Propulsion lever
- 10 Height adjustment lever
- 11 Fuel cap
- 12 Oil cap
- 13 Spark plug

Not all the accessories illustrated or described are included in standard delivery.

ASSEMBLY AND USE

Preparing to assemble the lawnmower



WARNING!

- Always take care when removing the packaging to prevent damage to you or to the lawnmower.
- This item requires a two person lift to remove from the packaging. Make sure that you have sufficient space to put the lawn mower down. Keep your feet apart so that you have a stable position, bend at the knees and keep your back straight.
- Always recycle the packaging in accordance with local recycling schemes.

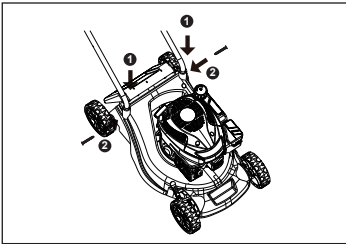

Step 1 - Assemble the lower handle



Remove the packaging from the handle.

Insert the lower handle into the deck as shown and on each side and fix it with a self-tapping screw.

NOTE! Press firmly down until the handle bottoms out in the holes or the cables will be too tight and the handle will not be secure.

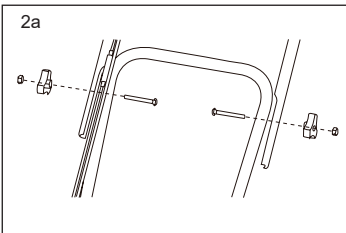

Step 2

Lift the upper handle, and lock in place using the quick release lever and tensioning bolts that are attached to the handle.

Ensure the lower and upper handles are firmly connected.

Ensure the rope guide is on the right handle, when you stand behind the mower.

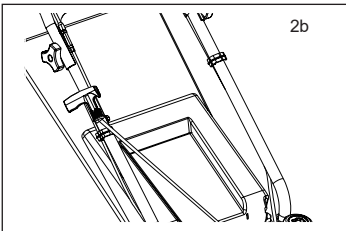

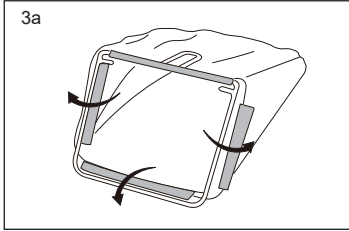

Step 3

3a. Firstly attach the grass bag to the frame by fixing all plastic hooks.

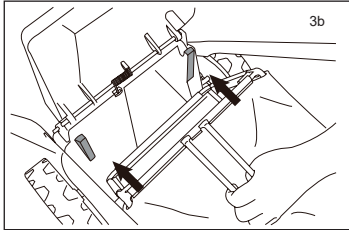

3b. Raise the safety flap, and hook the collection bag onto the mower.

Release the safety flap.

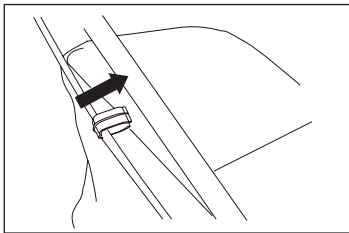

Step 4

4. Ensure that the cable clips supplied are used to fix the cable to the Lower Handle.

STOP!

Do not start the engine before putting 400ml of SAE 30 oil into the engine.

Failure to do so will result in irreparable damage to the engine and invalidate your warranty.

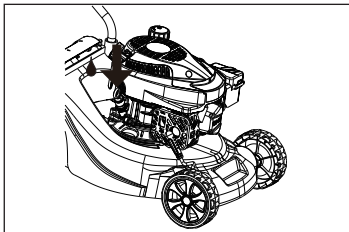

Preparing to Operate the Lawnmower

Step 1 - Filling with Engine Oil



IMPORTANT!

- The following procedures and adjustments must be performed before the engine is started. Do not attempt to make any of these adjustments while the engine is running.

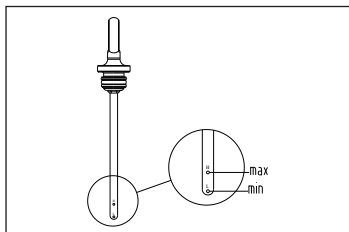

Always use high quality detergent oil classified SAE30 oil (or equivalent eg 5W 30, often termed as 4 Stroke lawn mower oil). Only use additives recommended by the engine manufacturer. To prolong the life of your engine it is important that the oil is changed after the first 5 hours of use. Using non-detergent oil can shorten the engine's service life and using 2-stroke oil will damage the engine.

To prevent engine damage the engine is shipped without oil or petrol. The engine must be filled with the correct grade of oil and petrol before starting the engine.

Running the engine with a low oil level will cause engine irreparable damage.

Check the engine oil level with the engine stopped and the mower on a level surface.

Remove the oil filler dipstick and wipe oil from it with a clean cloth.

Insert the dipstick into the oil filler neck, but do not screw it in.

Then remove the dipstick and check the oil level. The oil level must be between the Min and Max marks on the dipstick. If near the lower level, fill to upper level with the recommended oil (SAE30 or equivalent). Do not overfill. Wipe away any spilt oil.

Step 2 - Filling with Engine Fuel



WARNING!

- Refuel in a well-ventilated area with the engine stopped. Do not smoke or allow flames or sparks in the area where the engine is refueled or where petrol is stored. Avoid repeated or prolonged contact with skin or inhalation of vapour.



CAUTION!

- Petrol is highly flammable and extreme precaution must be taken when handling or working with it. Keep out of reach of children.

1. Clean the area around the petrol filler cap before removing the cap. Remove the warning tag, check the fuel level.
2. Refill the tank if the fuel level is low. Always use clean, fresh unleaded petrol. Purchase fuel in quantities that can be used within 30 days. Never mix oil with petrol.
3. Refuel carefully to avoid overfilling or spilling fuel to allow for expansion. There should be no fuel in the filler neck.
4. Clean up any overflow or splashes of petrol before starting the engine.
5. Tighten the filler cap after filling, finger tight only.



NOTE! The 40cm Hand Push Lawnmower has a maximum fuel capacity of 900ml.

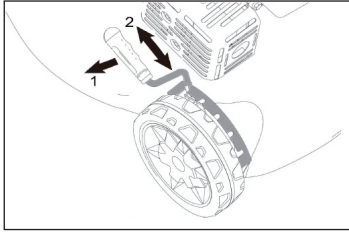

Operating the Lawnmower
Step 1 - Setting the Cutting Height



WARNING!

- The blade can cause serious injury. Before adjusting the mower height, stop the engine and wait for the mower blade to stop completely.

1. Pull the lever towards the wheel, then move it forward or backward to adjust the cutting height.
2. Move it to any one of the 5 positions for the desired cutting height.
3. Return lever into securing plate.



NOTE! Never use the lowest cutting height for the first cut of the season or in drought conditions.

Only about one thirds of the grass height should be cut.



Step 2 - Starting the Engine



WARNING!

- Do not operate the machine in enclosed or poorly ventilated areas as the exhaust gas contains toxic substances. Keep hands, feet, hair and clothing away from all the moving parts of the machine. The exhaust and other parts of the machine will become hot during use. Make sure that the blade is securely fastened before starting the engine.

Starting procedure quick guide

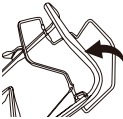
PRIMER BULB 3~5 TIMES	STOP/START-LEVER CLOSED	PULL STARTING -KNOB	PROPULSION-LEVER CLOSED
1 	2 	3 	4 

To start the engine, make sure that the spark plug cap is located on the plug and the machine is filled with sufficient oil and petrol.

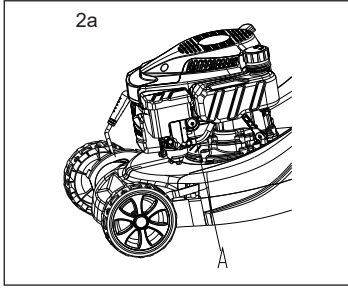

2a Press the primer bulb (A) 3-5 times.

When starting a cold engine, press down the primer fully 3~5 times.

Pressing the primer button too many times could cause the engine to flood. (too much petrol in cylinder causing hard start)



NOTE! When starting a warm engine, the primer does not need to be used. If the engine stops due to a lack of petrol, refill and press down the primer 3~5 times.

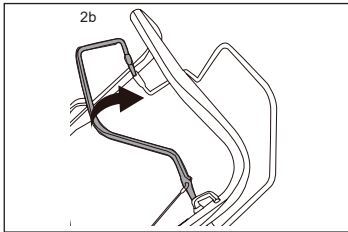

2b Start/Stop Bar Activation

Pull the Start/Stop bar towards you.

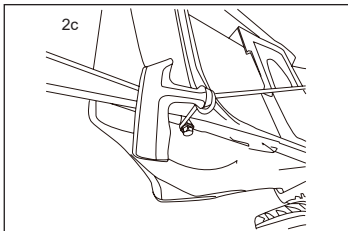

2c Pull cord handle

With right hand, slowly but firmly pull the starter handle and rope from the pull cord guide until you feel resistance, then pull briskly. If the engine fails to start after three pulls, repeat the start process. When the engine starts, return the starter rope to the pull cord guide gently.

3. To stop, release stop/start bar

Failure to start

If the engine won't start after you have operated the starter several times, the engine may be ooded with excess fuel.

Use following procedure to clear and start a flooded engine:

- A. Release the stop/start bar.
- B. Remove the spark plug, engage the brake lever, and pull cord 3~5 times.

Dry the spark plug, and then reinstall it.

Install the spark plug carefully by hand, to avoid cross-threading. After the plug is seated, tighten 1/8 to 1/4 turn with socket spanner of spark plug to compress the washer.

C. Pull the stop/start bar towards the upper handle.

D. Operate the starter as described above.

Step 3 - Mowing



WARNING!

- Always observe the strictest safety procedures when using the lawnmower.

Mowing with grass bag

Start the engine and allow it run .See "Step-2 Starting the engine"

Keep a firm grip on the upper handle with stop/start bar and walk bar closed and walk along with it self-propelling, never run with the mower, be very careful when mowing uneven or rough ground.

Mow across slopes, never up and down. Be careful when changing the direction of the mower on a slope. Do not use the mower on a steep slope of more than 15°.



NOTE!

- The best result will be achieved if the grass is dry. Wet grass will tend to clog the blade and the grass collection system. Grass grows at different rates at different time of the year.
- Never use the lowest cutting height for the first cut of the season or in drought conditions. Only about one thirds of the grass height should be cut.
- If the lawnmower will not collect the cuttings efficiently, the grass discharge chute may be blocked. The grass bag may be full, or the underside of the mower deck may be clogged.

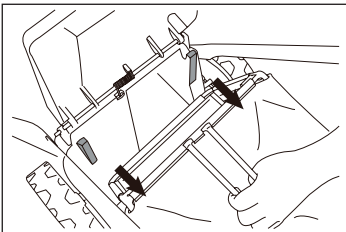

Step 4 - Emptying the Grass Bag



WARNING!

- Before removing the grass bag, always stop the engine.

- Raise the discharge flap with one hand and remove the grass bag using its handle with your other hand. To maintain safety, the discharge flap will close back to cover the mulching plug, when you release the flap.
- Empty the grass debris in the grass collection bag, and refit grass collection bag. If any grass residues are caught in the discharge chute, clean it using a brush.

CARE AND CLEANING

Maintenance

Storing the Lawnmower for Short Periods

After mowing please follow the below actions prior to placing the lawnmower in storage.

- Allow the engine to fully cool.
- Ensure the grass bag is empty.
- Clean all debris from under the mower deck.
- Store the lawnmower on flat and level surface with all 4 wheels on the ground.
- Store in a safe place which is not accessible by children or people who are not familiar with operation.

Storing the Lawnmower for Extended Periods



CAUTION!

- Do not empty the petrol tank in enclosed areas, near fire or when smoking. Petrol fumes can cause explosions and fire.

If the lawnmower is to be placed into storage at the end of the season or if the mower is not to be used for a longer period than 6 weeks, storage maintenance must be performed on the lawnmower.

The temperature fluctuations cause condensation which contaminates fuel and causes starting problems. Simply emptying the machine of fuel will prevent this.

- 1 Empty the petrol tank with a petrol suction pump if available or use the tipping method.
- 2 Start the engine and let it run until any remaining petrol has been used up.
- 3 Change the oil at the end of every season. To do so, remove the used engine oil from a warm engine and refill with fresh oil.
- 4 Remove the spark plug from the cylinder head. Fill the cylinder with approx. 20 ml of oil from an oil can. Slowly pull back the starter handle, which will bathe the cylinder wall with oil. Screw the spark plug back in.
- 5 Clean the cooling fins of the cylinder and the housing.
- 6 Be sure to clean the entire machine to protect the paint.
- 7 Store the machine in a well-ventilated place.

For more information watch our maintenance videos on www.coreservice.co.uk



NOTE: Alternatively adding Briggs & Stratton FUEL FIT to the fuel will prevent contaminated fuel.

Not all additives on the market do this. FUEL FIT can be ordered via www.coreservice.co.uk

Preparation to re-use

- Check oil level before starting the engine and ensure of sufficient oil level, see page 7.
- Check spark plug inserted correctly, see page 15
- Fill engine with fresh unleaded fuel, see page 8
- Follow starting procedure, see page 9

Maintenance Schedule



WARNING!

- Before you tip the lawn mower onto its side, completely empty the fuel tank using a petrol suction pump.
- Never turn the mower upside down.
- Before commencing any maintenance always disconnect the spark plug

Performing routine maintenance correctly on your lawnmower will ensure you get years of trouble free use.

Please keep this manual safe for future reference.

It is recommended that the following maintenance schedule is adhered to. This will ensure the lawnmower operated correctly and is safe to use.

	after every use	12 hours of use	24 hours of use	36 hours of use
Cleaning	clean	clean	clean	clean
Air filter		clean	clean	replace
Spark plug		check	clean	replace
Engine oil	check	check	replace	check
Cutting blade	check	check	check	replace

The Engine oil should be changed after the first 5 hours.

Cleaning

- To ensure long life and good performance of the machine its important to keep the machine clean and well lubricated. Make sure the chute is clean and under the deck is cleared from wet debris. see also short term storage.
- Do not allow grass cuttings and other debris to become dry and hard on any of the mower surfaces. This will directly affect the cutting and grass collection performance. Make sure that the underside of the lawnmower deck is clean and clear.
- Never clean the lawn mower with a water jet or high-pressure cleaner. The engine must remain dry. Do not use aggressive cleaning agents such as cold cleaner or petroleum ether.

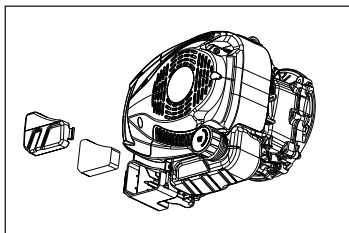

Cleaning or Replacing Air Filter



WARNING! Never run the engine without the air filter element installed.

1. Loosen the fastener that holds the cover.
2. Open the cover and remove the filter.
3. To loosen debris, gently tap the filter on a hard surface. If the filter is excessively dirty, replace with a new filter.
4. Install the filter.
5. Install the cover tabs into the slots.
6. Close the cover and secure with the fastener.

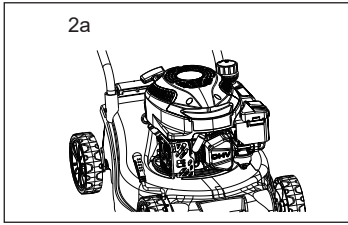

Cleaning or Replacing Spark Plug

2a Once the engine has cooled, pull off the spark plug boot with a twist. Remove the spark plug using the socket spanner supplied.

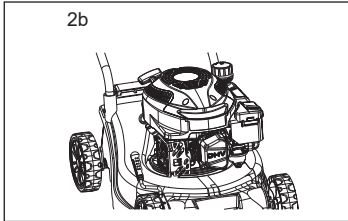

2b Clean the plug with a wire brush.

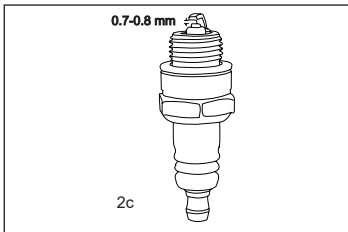

2c Using a feeler gauge set the gap to 0.7mm.

2d Install the spark plug carefully by hand, to avoid cross-threading.

2e After the spark plug is seated, tighten with the spanner to compress the washer.

Changing the Oil

Tilt the lawnmower towards the oil filler, have a container ready to catch the oil and remove the dipstick. Once the oil has been emptied, wipe clean any spillages.

Refill with 400ml SAE30 oil or equivalent ie SAE5W/30, SAE10W/30). When the dipstick is rested on the filler pipe, the oil level must be between the min and max marks on the dipstick.

See "Filling with Engine Oil". Do not overfill.

Start the engine and allow it to run briefly.

Stop the engine, wait one minute and check the oil level. Top up if necessary.

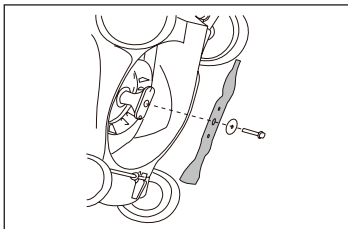

Replacing Cutting Blade



WARNING!

- Before you remove the grass collection bag, stop the engine and wait until the blade stops completely.

- You will need garden gloves (not provided) and a spanner wrench to remove the blade.
- Always handle the blade with care- sharp edges could cause injury USE GLOVES.
- Don't hold the blade by hand directly.

Renew your metal blade after 50Hrs mowing or 2yrs which ever is sooner regardless of condition.

Regularly check your blade. If the cut of your grass is poor, the blade might be blunt. Damaged blades not only result in a bad cut, they cause excessive vibration and uneconomical running of the engine. If the blade has worn excessively and become pitted and blunt, it should be replaced or sharpened.



NOTE: The blade carrier is designed to break under heavy blade impact to protect the machine. if this happens also replace the blade carrier. This can be purchased from www.coreservice.co.uk.

1. Tip the machine slightly towards the oil filler pipe and reach under the deck.
2. Hold the blade and unscrew the blade bolt counterclockwise using a spanner wrench. Remove the washer and the blade.
3. Inspect the blade adaptor on any signs of damage.
4. Fit a new blade, locate the blade on the two studs on the blade flange and then replace the washer and bolts.
5. Check the washer is still slightly domed to keep the pressure on the bolt to stop it unwinding, keeping the blade firmly secure. Then replace the washer (right way around!) and bolts.
6. Make sure the blade is correctly located, and then firmly tighten the bolt. Do not over tighten. The up turn of the blade must project into the motor compartment.



NOTE! If you are unsure about performing this operation call our helpline or go to an authorised dealer to change the blade for you.

List of consumable parts

TORCH/F5RTC	Spark plug	1250849000	Blade bolt
1052404000	Collection grass bag	1050409000	Fixing knob
1251438000	Blade		

TROUBLE SHOOTING



WARNING!

- Always switch off the engine and pull the ignition cable before starting any inspection or adjustment work.
- If, after making an adjustment or repair to the engine, you let it run for a few minutes, remember that the exhaust and other parts will get hot.

The following table provides solutions to common problems encountered with the lawnmower.

Fault	Possible Cause	Solution
Loud while running, machine vibrates heavily	<ul style="list-style-type: none"> - Screws are loose - Blade fasteners are loose - Blade is unbalanced 	<ul style="list-style-type: none"> - Check screws - Check blade fasteners - Replace blade
Engine does not start	<ul style="list-style-type: none"> - start/stop bar not pressed - Primer bulb is empty - Spark plug is defective - Fuel tank is empty - Engine may be flooded 	<ul style="list-style-type: none"> - Press start/stop bar - Press primer bulb 3~5 times. - Replace spark plug - Refill with fuel - remove plug and dry
Engine runs unsteadily	<ul style="list-style-type: none"> - Air filter is soiled - Spark plug is soiled 	<ul style="list-style-type: none"> - Clean the air filter - Clean the spark plug
Uneven mowing results	<ul style="list-style-type: none"> - Blade is blunt - Cutting height is too low 	<ul style="list-style-type: none"> - Sharpen the blade - Set correct height
Unsatisfactory grass collection	<ul style="list-style-type: none"> - Cutting height is too low - Blade is worn - grass bag is clogged 	<ul style="list-style-type: none"> - Set correct height - Replace the blade - Empty the grass bag

DECLARATION OF CONFORMITY / PERFORMANCE



Product Code: 81854/XSZ40B

Product Description: Hawksmoor 127.1cc 40cm Self Propelled Petrol Lawnmower

1. Toolstation Limited, Express Park, Bristol Road, Bridgwater, Somerset TA6 4RN

This declaration of conformity is issued under the sole responsibility of Toolstation

2. Object of the declaration

The object of the declaration described above is in conformity with the relevant Community harmonization legislation:

Supply of Machinery (Safety) Regulations 2008

2006/42/EC

Electromagnetic Compatibility Regulations 2016

2014/30/EU

The Restriction of the Use of Certain Hazardous Substances in Electrical and Electronic Equipment Regulations 2012

2011/65/EU&(EU)2015/863

Noise Emission in the Environment by Equipment for use Outdoors Regulations 2001

2000/14/EC amended by 2005/88/EC:

- | | |
|--|----------|
| - Conformity Assessment Procedure as per | Annex VI |
| - Measured Sound Power Level | 94 dB(A) |
| - Declared Guaranteed Sound Power Level | 96 dB(A) |

3. References to the relevant standards used (or references to the specifications in relation to which conformity is declared:

BS EN ISO 5395-1, BS EN ISO 5395-2, BS EN ISO 14982, BS EN ISO 3744

4. Additional information:

Signed for and on behalf of Toolstation Limited

ENVIRONMENTAL INFORMATION

Old products are potentially recyclable and do not, therefore, belong in your household rubbish. You are requested to assist us and our contribution to saving resources and protecting the environment by handing in this product at an equipped collection centre (if there is one available).

Petrol, oil, used oil, a mixture of oil and petrol and objects soiled with oil e. g. cleaning cloths do not belong in the household rubbish. Dispose of oil-contaminated items in accordance with the local guidelines and hand them in at recycling centres.

The product comes in a package that protects it against damage during shipping. Keep the package until you are sure that all parts have been delivered and the product is function properly. Recycle the package afterwards.

GUARANTEE

Toolstation products deliver reliable service for normal, household use in domestic settings. All Toolstation products are individually tested before leaving the factory.

If you are a consumer and you experience a problem with your Toolstation product, which is found to be defective due to faulty materials or workmanship within the Guarantee Period, this Toolstation Guarantee will cover repair or - at the discretion of Toolstation - replacement with a functionally equivalent Toolstation product.

Your product is under guarantee for 2 year from the date of purchase or the date of delivery of the product, if later.

The guarantee is subject to the following provisions:

- The guarantee does not cover accidental damage, misuse, cabinet parts, knobs, or consumable items.
- The product must be correctly installed and operated in accordance with the instructions contained in this manual.
- It must be used solely for domestic purpose.
- The guarantee will be rendered invalid if the product is re-sold or has been damaged by inexpert repair.
- Specifications are subject to change without notice.
- The manufacturer disclaims any liability for the incidental or consequential damages.
- The guarantee is in addition to, and does not diminish your statutory or legal rights.

CUSTOMER SUPPORT

www.coreservice.co.uk

Call us +44 01904 947568

Email: support@coreservice.co.uk

Made in China