

Troubleshooting guide

Problem	Possible cause	Solution
Economy function failure (GREEN LED on control panel not visible when ECONOMY button pressed)	Heating function is not ON	PIR function is effective with LIVE heating only. Please turn on heating mode.
	PIR / PCB malfunction	Please call the technical helpdesk

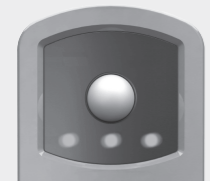

Problem	Possible cause	Solution
ORANGE LEDs flashing	Safety Warning Indicator	If any or all of the 3 ORANGE LED Indicator Lights start to flash or flicker intermittently, this indicates a problem within the internal control systems of the unit. Please switch off the unit immediately, leave for 30 minutes and switch on again. If this continues to occur please call the technical helpdesk



Problem	Possible cause	Solution
Light not working	Power Switch OFF	Make sure the Power Indicator LED is on by turn Power Switch ON at the heater's back. Then press light button on control panel or remote control.
	No Power to unit	Check the mains or the socket or plug's fuse(if there is) to restore circuit.
	Safety Thermal Fuse in Operation.	Unplug and switch unit OFF. Wait 30 minutes for unit to auto-reset then switch on. Repeat if necessary. If this continues to occur please call the technical helpdesk
	Safety Tip Over Switch Malfunction	Safety Tip Over stuck in OFF position. Give the unit a rigorous shake which may reset the switch. If this does not rectify the problem, please call the technical helpdesk
	Lamp is faulty	Replace as necessary. This unit uses specialised high temperature low energy lamps only. These are only available from the technical helpdesk
	Heater not on a level Surface	Ensure Heater is situated on a level and solid surface.

Problem	Possible cause	Solution
Control Panel Inoperative	MasterLock is in operation Or Buttons stuck / PCB malfunction	See Masterlock Function page 9 to unlock the control panel Please call the technical helpdesk



Amber 3000W Outdoor Heater With PIR ZR 37442 GMTL

Helpline

If you receive this item with parts broken or missing, please telephone:

0333 0050077

Please have ready your name, address, tel. no., product reference, where purchased and parts required. An answering service is in operation outside office hours and during busy periods.

We regret that we are unable to give advice on internal house wiring.

This product has been manufactured to comply with EEC Directives 2006/95/EG and 89/336/EEC.

Not household waste. Must be disposed of in accordance with local regulations.



UK MANUFACTURER / IMPORTER
CASCADE HOLDINGS LTD.
GORSE MILL
GORSE STREET
OLDHAM,
UNITED KINGDOM
OL9 9RJ



EU AUTHORISED REPRESENTATIVE:
AUTHORISED REP COMPLIANCE
GROUND FLOOR
71 LOWER BAGGOT STREET
DUBLIN
IRELAND
D02 P593





Safety instructions

WARNING - When using electrical appliances, basic safety precautions should always be followed. Failure to comply with these instructions may cause a fire, electrical shocks or other injury to persons or property.

- 1 Children of less than 3 years should be kept away unless continuously supervised.
- 2 Not suitable for use by children.
- 3 **CAUTION** — Some parts of this product can become very hot and cause burns. Particular attention has to be given where children and vulnerable people are present.
- 4 **DO NOT** position the heater on soft surfaces or where openings may become blocked. Ensure the base is fitted and fully assembled, and the unit is upright on a flat stable surface before operating. This heater is designed for use on Patios and in Beer gardens & smoking areas. The unit has been IP55 Weatherproof approved; however, to prolong the life of the heater it is strongly recommended that the heater is stored in a dry place during heavy rain and when not in use cover the appliance with the cover provided.
- 5 **DO NOT** hide the power cord in long grass or leave close to an operating lawnmower. Arrange the cord away from areas where it may be tripped over.
- 6 **DO NOT** insert or allow objects to touch the heating element and never place anything on the heater safety guard (e.g. towels), as this may damage the heater and could cause an electrical shock or fire. Never use your heater to dry washing. If the heating element has stopped glowing it may still be live, please check that the heat setting indicates the heater is off.
- 7 Always disconnect your appliance from the mains before any cleaning.
- 8 **DO NOT** use the heater in areas where petrol, paint, or other flammable substances are stored.
- 9 Always unplug the heater when not in use. To disconnect from the power supply, grip the plug and pull from the power socket. Never pull by the cord.
- 10 **DO NOT** direct the heater towards curtains, furniture or other flammable objects and ensure that they are at least 1.5 metres from the front and 1 metre from the top, back and sides.
- 11 Extreme care should be taken when the heater is used near children and pets.
- 12 In order to avoid overheating, do not cover the heater.

Trouble shooting

Problem	Possible cause	Solution
Heater won't operate (indicated by the absence of the red LED power standby light being visible in the unit control panel display) Not visible 	Power Switch OFF	Turn Power Switch ON at the back of the heater.
	No Power to unit	Check the mains or the electrical socket to restore circuit.
	Safety Thermal Fuse in Operation.	Unplug and switch unit OFF. Wait 30 minutes for unit to auto-reset then switch on. Repeat if necessary. If this continues to occur please call the technical helpdesk
	Safety Tip Over Switch Malfunction	Safety Tip Over stuck in OFF position. Give the unit a rigorous shake which may reset the switch. If this does not rectify the problem, please call the technical helpdesk
	Heater not on a level surface	Ensure Heater is situated on a level and solid surface.
	Power Cord Damaged	Inspect power cable for cuts, breaks and kinks. Replacement power cords and fitting instructions can be obtained from the technical helpdesk

Problem	Possible cause	Solution
Heat tubes only not working (indicated by the presence of the RED power standby light being visible in the unit control panel display but no heat from tubes) Visible 	Tube Failure / Safety Thermal Fuse in operation.	Firstly try the following procedures to ensure it is in fact the tubes that are faulty. 1) If one tube out then the tube is faulty and should be replaced. 2) If two tubes out then push the remote on/high/med button again just to check the tubes don't heat up. Also try pushing the button on the control panel "on/high/med button" & "off" button again in case any have jammed in some way. 3) If still no tubes heating – then check if any of the Orange Power LED's are on? If LEDs are ON (ORANGE) then tube / tubes have blown. If NO LED's are lit and NO tubes are heating up then wait 30 minutes for unit to auto-reset then switch on. Repeat if necessary. If this continues to occur please call the technical helpdesk This unit uses specialised high temperature carbon fibre heating tubes only. For replacements, please call the technical helpdesk
	Blown Carbon Fibre Tubes	Blown tubes are usually visible. Check for black or white discolouration at either end of the tubes.

Problem	Possible cause	Solution
Remote control inoperative	Battery dead	Make sure the red power indicator is visible otherwise you need to replace battery (Type CR2032).

Remote control

Operational range of remote is approx 4m (open air) as it is infrared only.

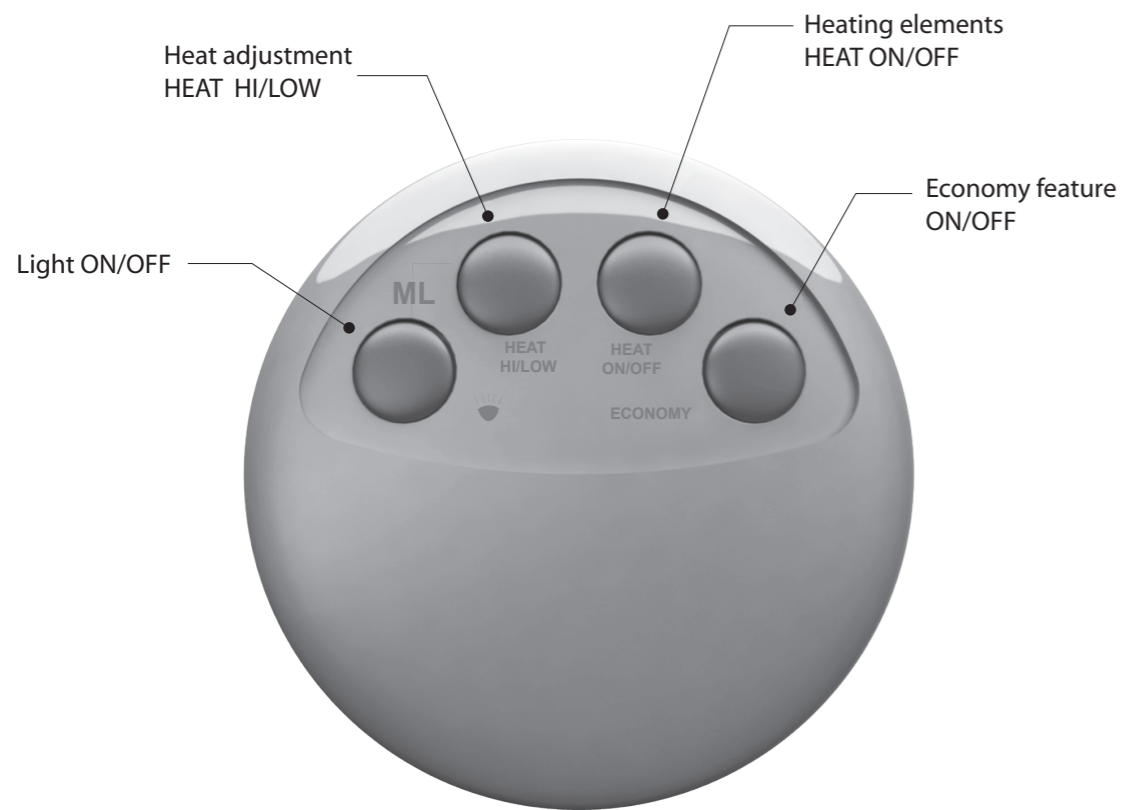

“Full Function” magnetic remote control that attaches easily to the unit. Do not attach to the grille.

Masterlock function



Masterlock function enables you to Auto-Lock the control panel using the remote control to avoid tampering.

LOCK

- 1 : Press the light button & Hold down
- 2 : Followed by the HEAT HI/LOW button
- 3 : Hold both buttons simultaneously until you hear the Appliance beep 5 times

If you accidentally switch off the light function then press the light button on the remote again to put the light back on.

UNLOCK

Simply repeat the above process

- 13 Never locate the heater where it may fall into a swimming pool or other water container. Never use in a bathroom or shower room. Heater should not be positioned directly under a socket outlet.
- 14 Do not use this heater in conjunction with a timer device or any other device, which facilitates unattended switch on.
- 15 The electrical cord must be fully unwound before use.
- 16 The front grille is intended to prevent direct access to the heating elements and must be in place when the heater is on.
- 17 If the supply cord is damaged, it must be replaced by the manufacturer, its service agent or similarly qualified persons in order to avoid a hazard.

General information

Before use

This product has been designed for domestic and commercial use, to heat outdoor spaces using energy efficient carbon fibre infrared technology. It must only be used for this intended purpose and should be operated according to the instructions included in this manual. Please carefully read all operating and safety instructions before use. Never cover appliance when in operation and ensure that flammable objects (clothes, curtains, etc.) cannot come in close contact with the appliance.

Technical data

Model No.: DPH3000 or see Rating Label
Power output : 2520-3000W 220v-240v AC ~ 50/60Hz or see Rating Label
Heater watts : 2500-2960W or as per Rating label
Lamp watts : 12 W Tri-light LED as per Box
Cable length : 1.9m or as per outer box
Gross weight : 26.3 kgs Net weight : 21.7 kgs
Product Dimension: 50cm Base diameter & 169 cm high

The product is IP55 weatherproof certified. It is designed to withstand tough rain conditions. A cover is included for storage protection. We recommend that you should cover and store in a dry place when not in use for long periods of time.



Box contents

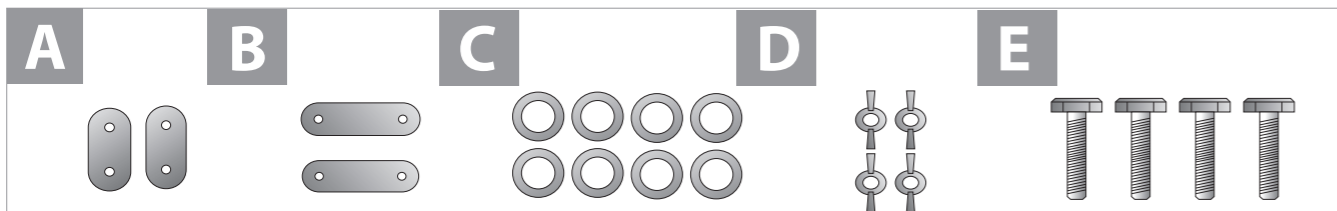

Assembly kit: 2 X Oval plates 2 X Long oval plates 12 X Washers 8 X Wing nuts 4 X Bolts

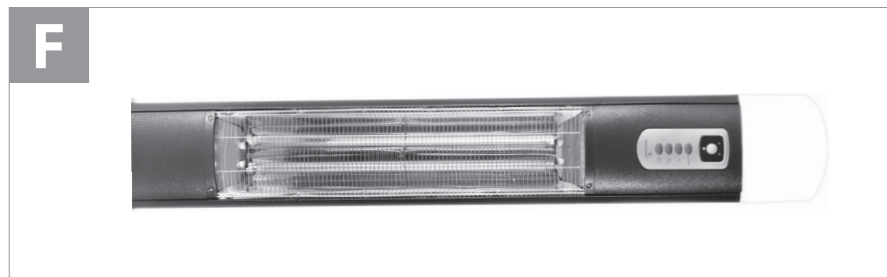

1 X Main body

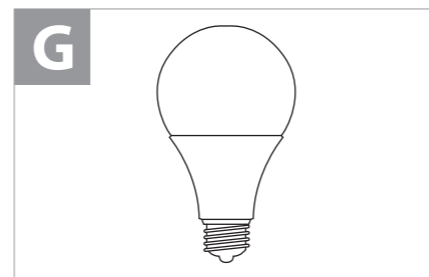

1 X LED lamp



1 X Remote control



1 X Storage cover

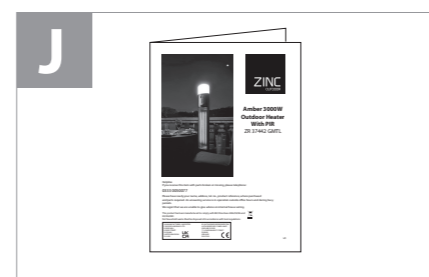

1 X Instruction manual

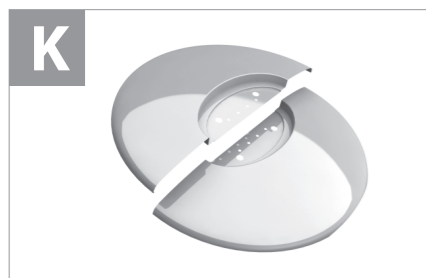

2 X Metal base covers



2 X Base sections and 2 wheels with axle

Cleaning and maintenance

- 1 Before cleaning or changing heating tubes, turn the heater off, unplug from the power supply and wait for the unit to cool down. To clean the heater use a soft cloth to wipe off any dust.
- 2 If the heater is very dirty, use a damp cloth and wipe dry. Do not use any cleaning detergents, sprays or other chemicals, as they will damage the unit.
- 3 When the heater is not in use for a long period, clean and place in its cover and store in a dry place.
- 4 If the Aluminium reflector is very dirty use a damp cloth and wipe dry. Do not use any cleaning detergents, sprays or other chemicals, as they will damage the unit. A dirty reflector reduces heater output.

Control panel operation

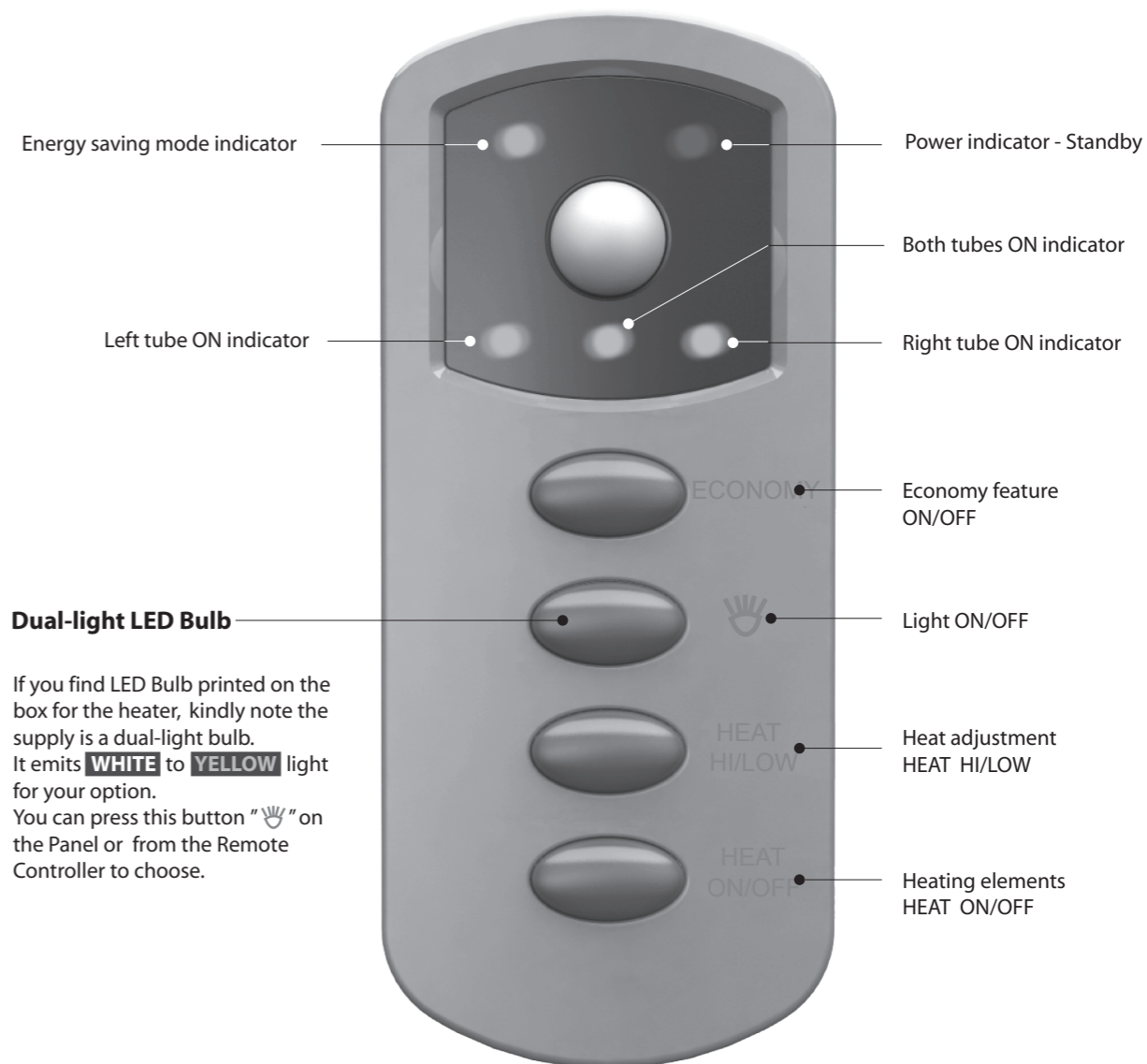

PIR Economy function

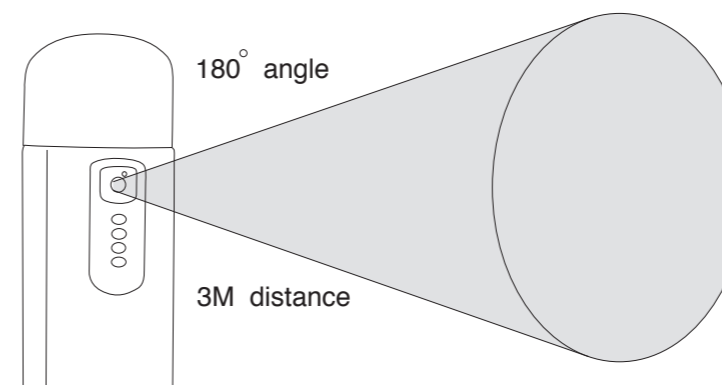

The PIR economy feature enables the outdoor heater to automatically shut down its heating function when not in use. The PIR sensor constantly monitors people's movements up to a distance of 3 metres and if after 4 minutes it does not detect movement it will switch the heating off. The heating won't be on afterwards unless you operate from the panel or the remote controller. The PIR function does not control the Light.

Moving & Positioning instructions

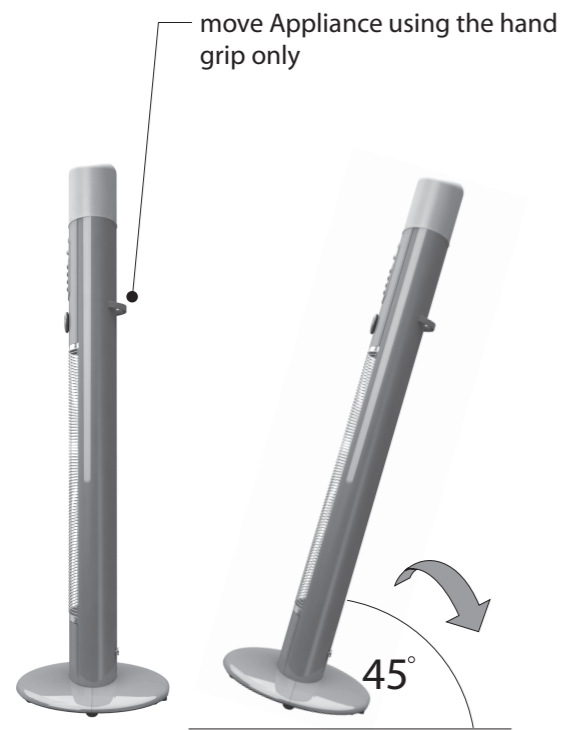

Ensure Appliance is turned off, completely cooled down and unplugged before moving.
Use the hand grip located on the rear of the unit to manoeuvre the Appliance. To ensure the lifetime of the Glass Heating Tube, avoid shakes, shocks, vibrations during moving.

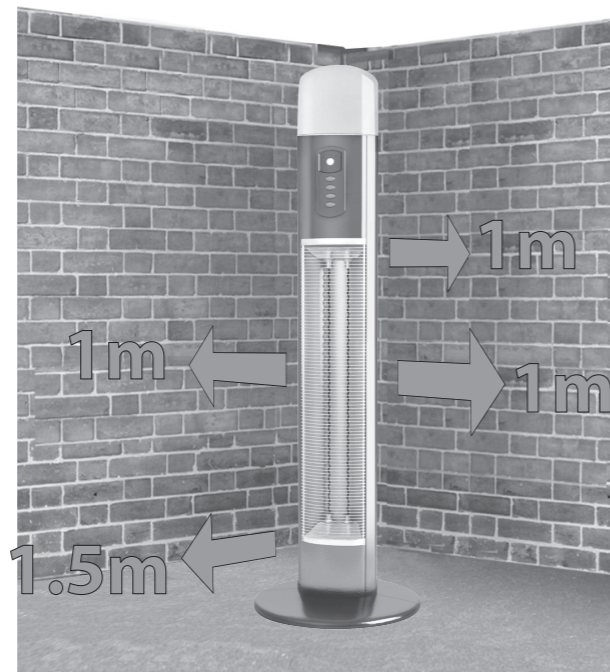

Observe recommended safety distances from Surrounding objects

Base & unit assembly (take out base accessory from the box underneath main body)

Lie main body(F) on the edge of its box to avoid scratching and for easy assembly with the base.

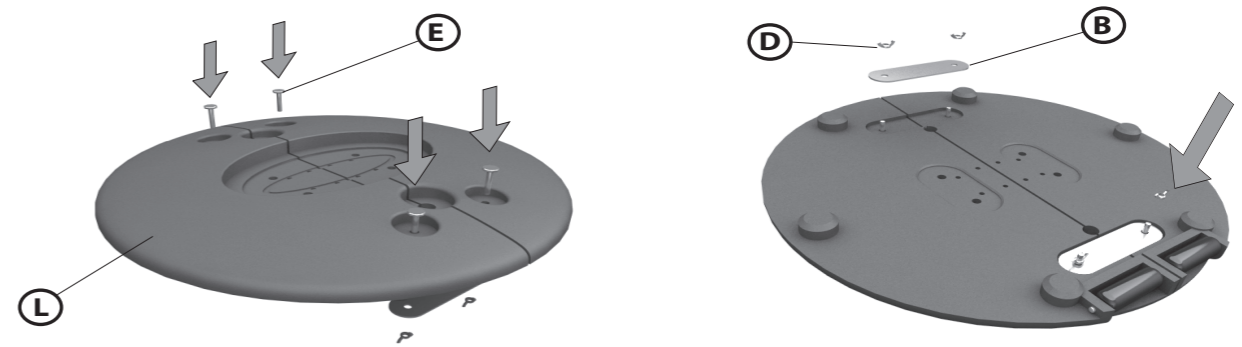

- 1 Align the two halves of the Base(L), make sure the wheel and axle are in position. Insert bolts with washers (E x 4 + C x 4).
- 2 Turn the Base upside down and securely fasten metal plates (B x 2) with wing nuts and washers (D x 4 + C x 4).



- 3 Attach each half of the metal cover. (K x 2)
One half of the metal cover has a cut-out that should be placed over the rollers.

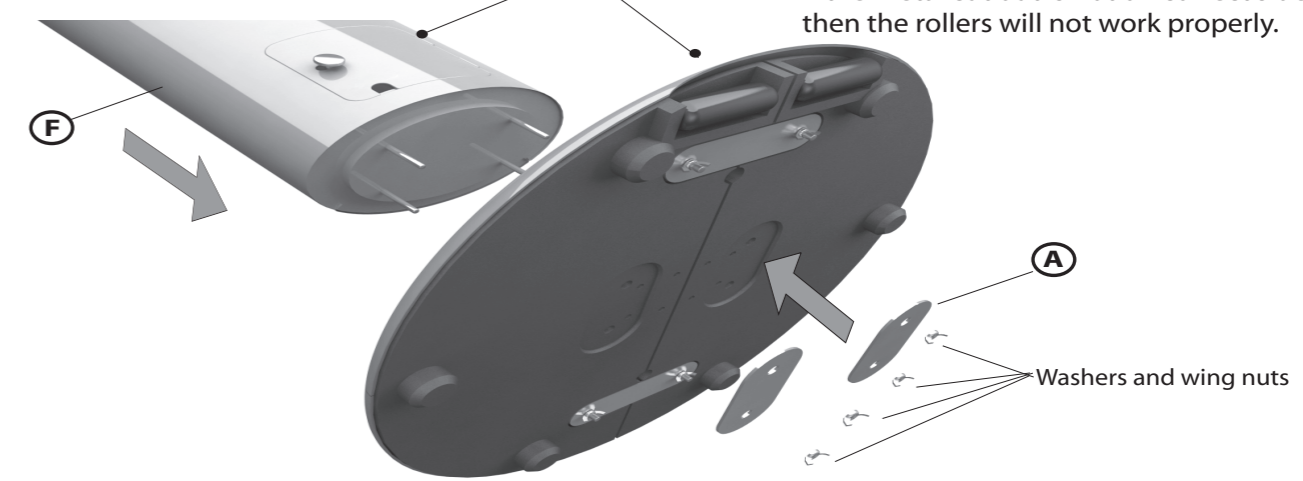

- 4 Slide the base through the four bolts located on the bottom of main body (F). Securely fasten metal plates (A x 2) with the wing nuts and washers (D x 4 + C x 4).

Remote Control battery replacement

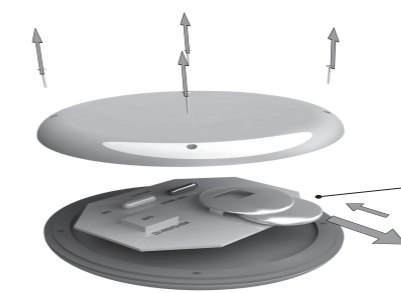

- A Unscrew the rear housing with a Phillips driver or cross point screw driver.
- B Replace CR2032 battery.
- C Carefully screw the rear housing back in place. Ensure that the rubber seal is properly in place and secure.

Lamp installation & replacement

Installation

- A** Remove protective materials around the packing and take the Lamp out. Carefully screw it into the Holder - Hold plastic base ONLY. Do NOT hold the glass spiral tube.
- B** Carefully fit the plastic light dome on to the plastic rim. Use light pressure until it clicks in place.



Replacement

- A** Using a flatblade screwdriver, insert the blade into one of the two slots on the rear of the plastic light dome. Using a slight twist action to pop off the plastic dome.
- B** Unscrew the faulty lamp and repeat the installation procedure with a new lamp. Only use lamp purchased from the company in Warranty card.
- C** Carefully refit the plastic light dome on to the plastic rim. Use light pressure until it clicks in place.



Appliance description and features

IP55
Weatherproof design



Built in light

Use only Max 40W ES CFL energy saving lamps or LED lamps supplied by the company

PIR Economy sensor

PIR (Passive Infrared) economy feature automatically turns off the heating when there is no movement for approx 4 mins.

Control panel

There are four slices of Sponges protecting the heating tubes & one Instruction Paper Card on the Grille.

BEFORE USE the heater, remove the Sponges and the Card by pulling them out.

Infrared heating elements

Carbon fibre technology creates FAR Infrared radiation

Dome light head
DO NOT lift or pull the product using the light head as this can damage the unit and invalidate your warranty

Power ON/OFF switch
Turn on to activate control panel and remote control.

Hand grip
Only move the appliance with the hand grip.

Safety tip over switch
Appliance switches off if it tips-over. Return the unit to the upright position and switch on to continue using.

Cable storage compartment and rating label position

Transport rollers

